

OBRIGATÓRIO FIXAR NA PAREDE
OBLIGATORIO DE FIJAR EN LA PARED
MANDATORY TO FIX ON THE WALL

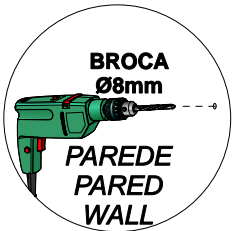

FIXAÇÃO NA PAREDE
MONTAJE EN LA PARED
WALL ASSEMBLY

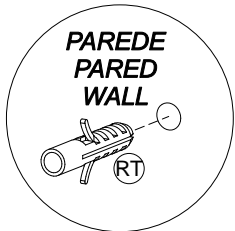
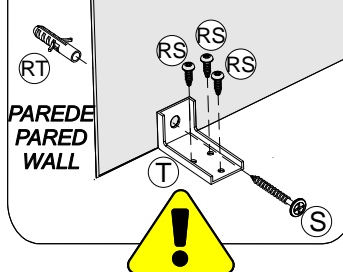

INSTRUÇÕES DE MONTAGEM
INSTRUCCIONES DE ARMADO
ASSEMBLY INSTRUCTIONS

REF.: 2660

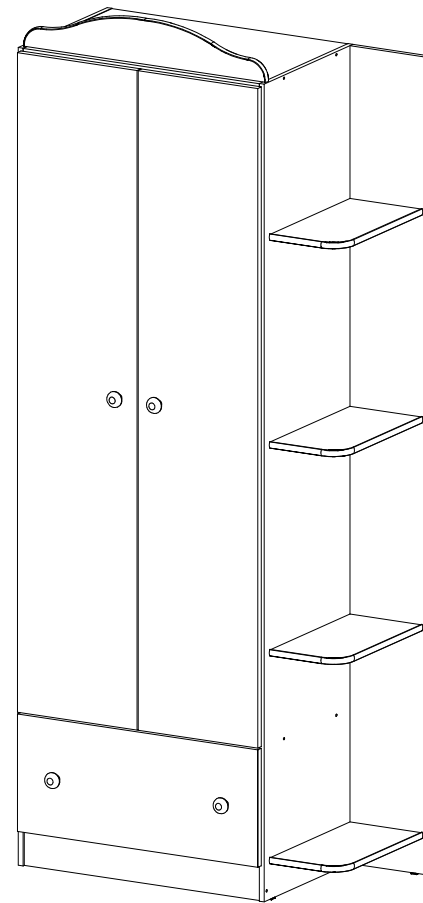
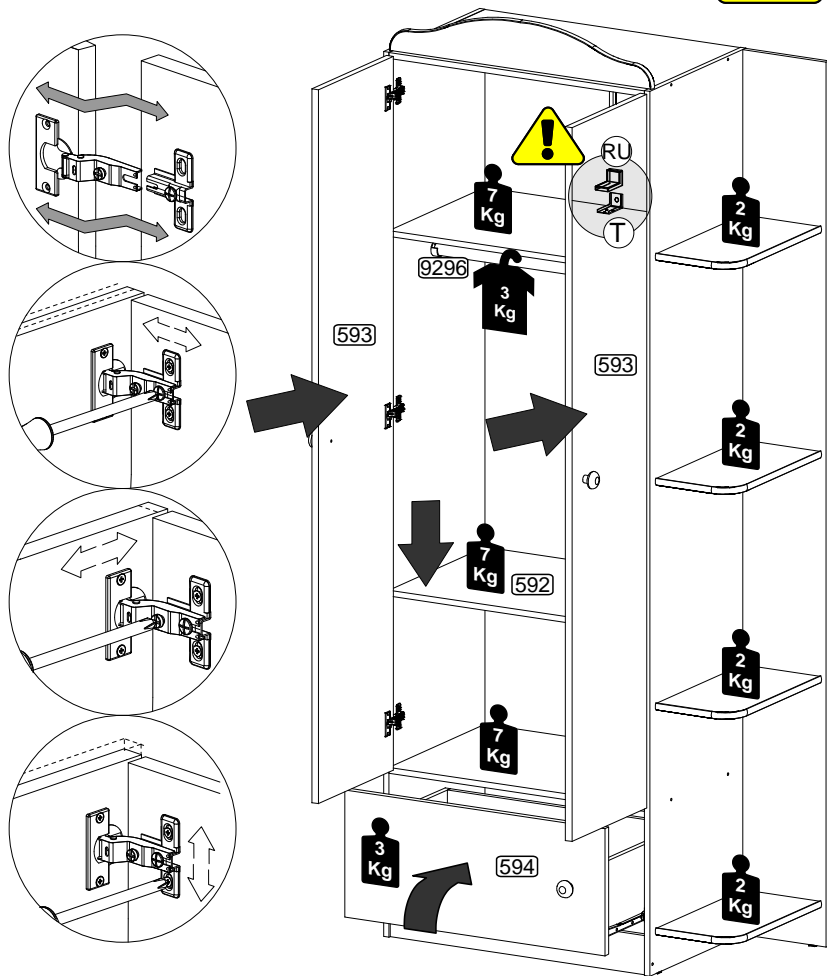

OBS: Moldura e rodapé com opções de cores:

- ROSA
- AZUL
- BRANCO
- CINZA

OBRIGATÓRIO FIXAR NA PAREDE
OBLIGATORIO DE FIJAR EN LA PARED
MANDATORY TO FIX ON THE WALL

FERRAMENTAS NECESSÁRIAS
HERRAMIENTAS NECESARIAS
TOOLS NECESSARY

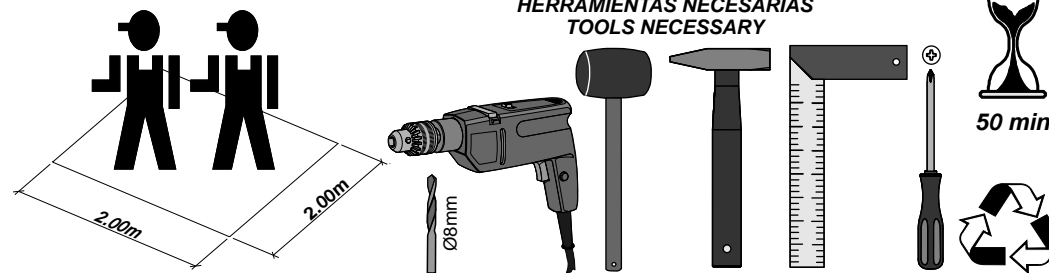











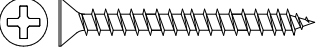
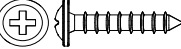

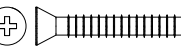

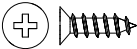
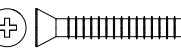

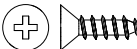

Utilizar a régua abaixo para medir as ferragens:

Utilizar la regla abajo para medir los herrajes: Use the ruler below to measure the hardware:

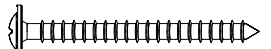

2 OBRIGATÓRIO FIXAR NA PAREDE
OBLIGATORIO DE FIJAR EN LA PARED
MANDATORY TO FIX ON THE WALL

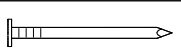
A	 Tampa Adesiva Papel	19
AA	 Dobradiça	06
AT	 Cantoneira Plástica	04
B	 4,0 x 40	24
BW	 4,0 x 30	04
BX	 COLA Bisnaga de Cola 12g	01
BZ	 Sapata L	05
C	 3,5 x 25	01
CA	 Corrediça roldana 350mm	01
CC	 3,5 x 12 Cab. pequena	26
D	 3,5 x 35	04
DX	 Suporte de prateleira	04
E	 3,5 x 12	24
F	 3,5 x 10	02
H	 Cavilha 6,0 x 30	32
O	 Sup. Cabideiro	02
PX	 Puxador	04
RS	 3,5 x 12	03
RT	 Bucha 8Ø	01
RU	 Proteção p/ Suporte	01
S	 5,0 x 45	01
T	 Suporte Aereo	01
Y	 Prego 10 x 10	49

Passo
Paso
Step
05

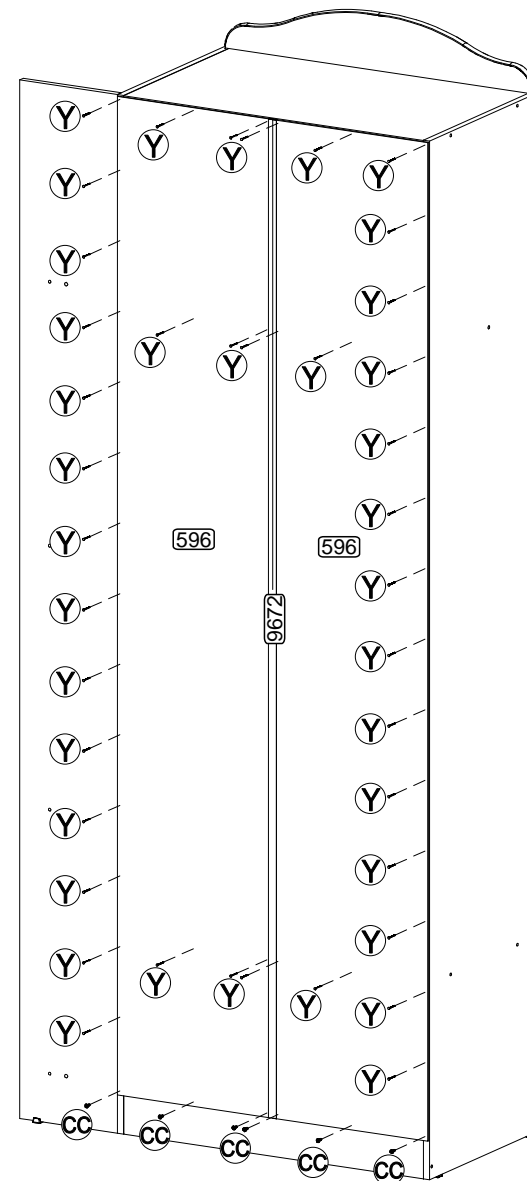
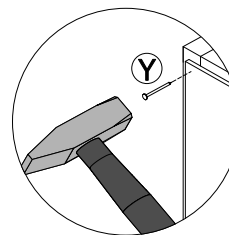

Passo
Paso
Step
03

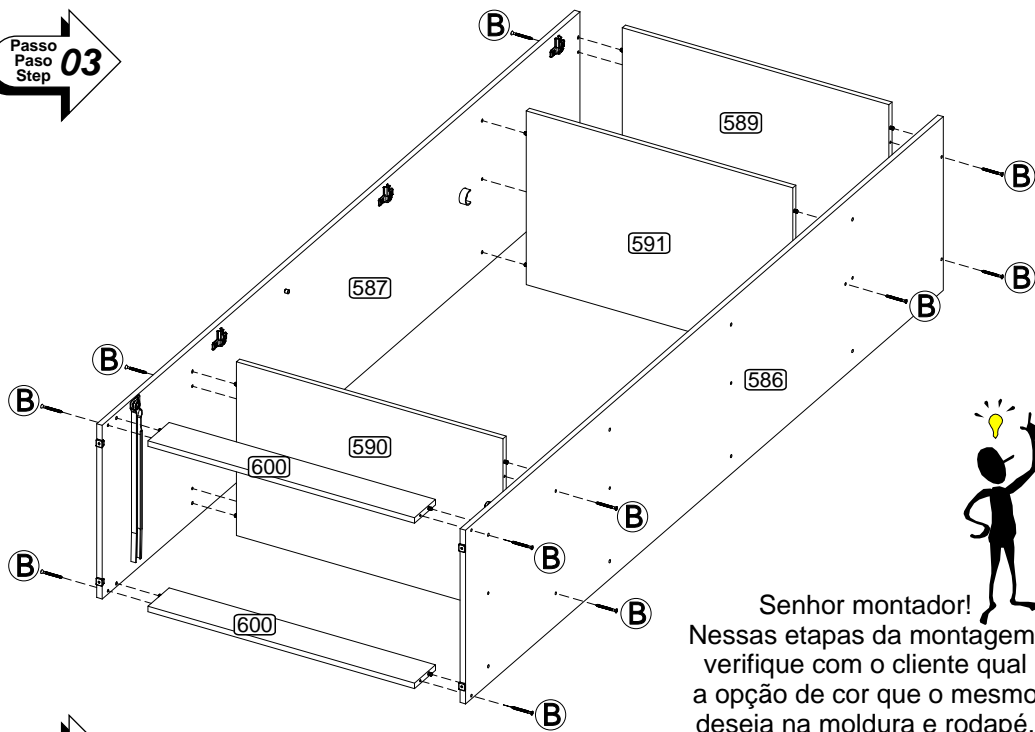

Senhor montador!
Nessas etapas da montagem,
verifique com o cliente qual
a opção de cor que o mesmo
deseja na moldura e rodapé,
ROSA, AZUL, BRANCO
ou CINZA, somente depois
prossiga a montagem.

Passo
Paso
Step
04

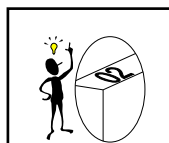
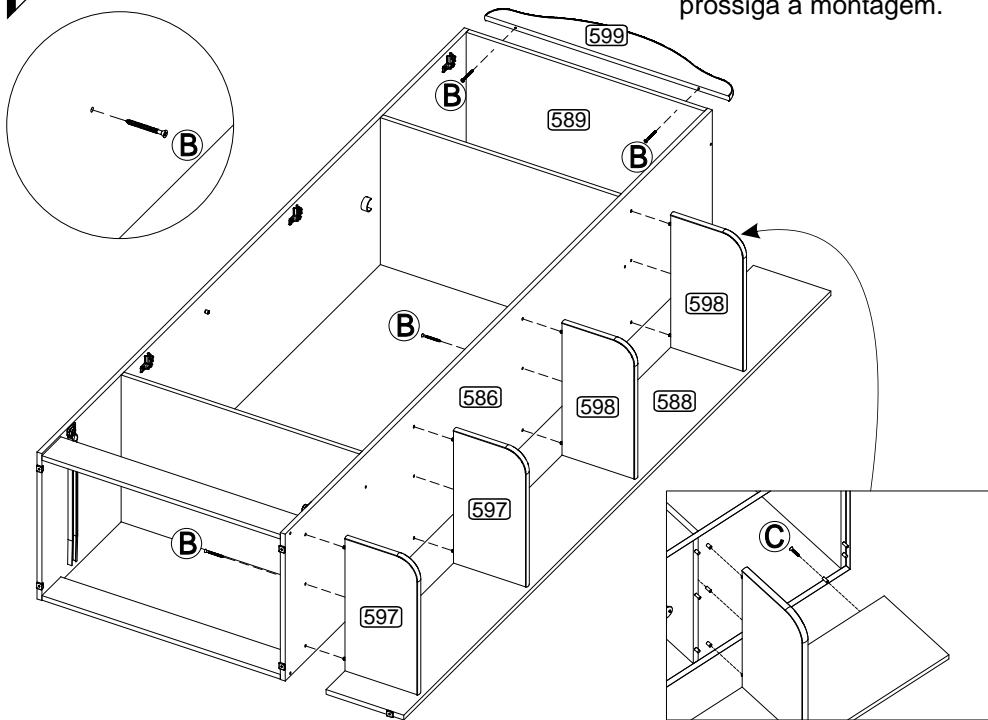

Senhor montador!
Informamos que
a numeração
das peças
encontra-se no
topo das mesmas
conforme
desenho.

Señor Armador!
Les informamos
que la numeración
de las piezas se
encuentran arriba
de las mismas,
de acuerdo al
modelo.

Dear Assembler!
We inform you
that the number
of each piece is
located on the
top of it, according
to the model.

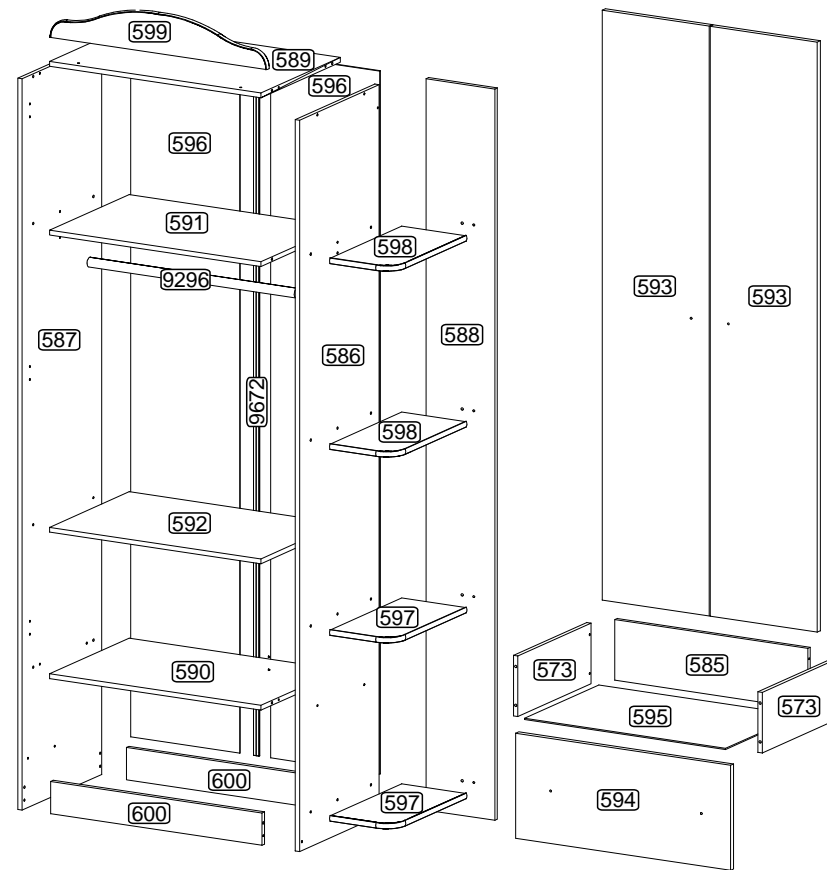

POR

LISTA DE PEÇAS

Nº	DENOMINAÇÃO
573	LATERAL DE GAVETA
585	COSTA DE GAVETA
586	LATERAL DIREITA
587	LATERAL ESQUERDA
588	COSTA
589	TAMPO
590	TAMPO GAVETA
591	TAMPO INTERMEDIÁRIO
592	PRATELEIRA MOVEL
593	PORTA
594	FRENTE DE GAVETA
595	FUNDO DE GAVETA
596	COSTA
597	PRATELEIRA INFERIOR
598	PRATELEIRA
599	MOLDURA ROSA/AZUL
599	MOLDURA BRANCO/CINZA
600	RODAPÉ ROSA/AZUL
600	RODAPÉ BRANCO/CINZA
9296	CABIDEIRO
9672	PERFIL I

ESP

LISTA DE PIEZAS

Nº	DENOMINACIÓN
573	LATERAL CAJÓN
585	RESPALDO CAJÓN
586	LATERAL DERECHA
587	LATERAL IZQUIERDA
588	RESPALDO
589	TAPA
590	TAPA CAJÓN
591	TAPA INTERMEDIARIA
592	ESTANTE MOVIL
593	PUERTA
594	FRENTE CAJÓN
595	FONDO CAJÓN
596	RESPALDO
597	ESTANTE INFERIOR
598	ESTANTE
599	MOLDURA ROSA/AZUL
599	MOLDURA BLANCO/GRIS
600	ZÓCALO ROSA/AZUL
600	ZÓCALO BLANCO/GRIS
9296	PERCHA
9672	PERFIL I

ENG

PART LIST

Nº	DESCRIPTION
573	DRAWER SIDE
585	DRAWER BACK
586	RIGHT SIDE
587	LEFT SIDE
588	BACK
589	TOP
590	DRAWER TOP
591	INTERMEDIATE TOP
592	MOVABLE SHELF
593	DOOR
594	FRONT DRAWER
595	BOTTOM DRAWER
596	BACK
597	LOWER SHELF
598	SHELF
599	FRAME PINK/BLUE
599	FRAME WHITE/GREY
600	SKIRTING BOARD PINK/BLUE
600	SKIRTING BOARD WHITE/GREY
9296	HANGER
9672	I PROFILE

PRÉ-MONTAGEM / PRÉ-ARMADO / PRÉ-ASSEMBLAGE

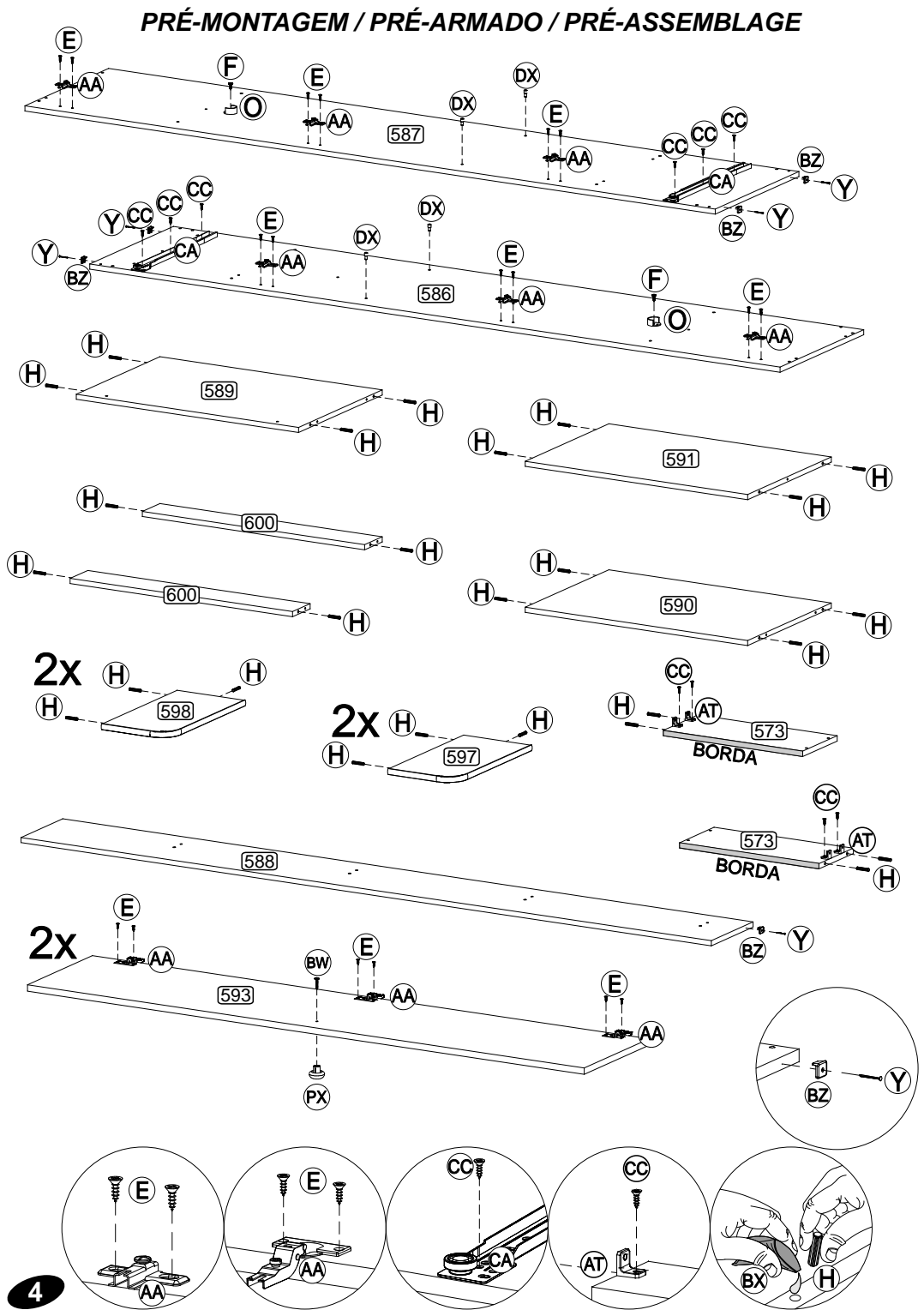

4

Passo Paso Step 01

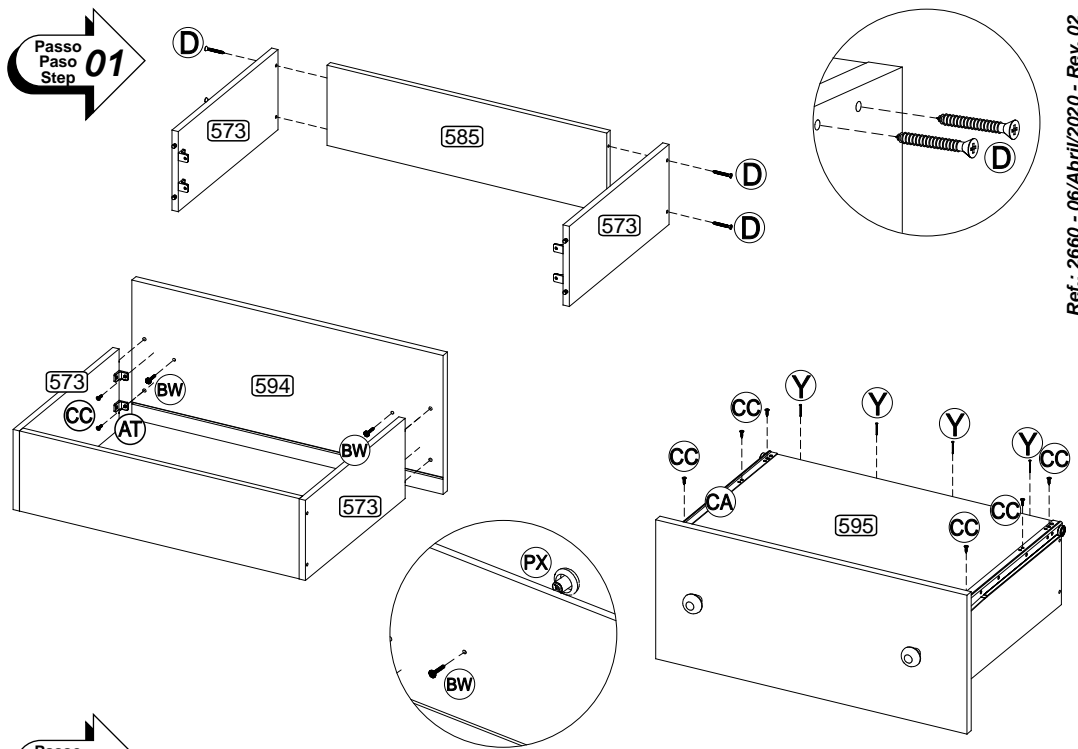

Passo Paso Step 02

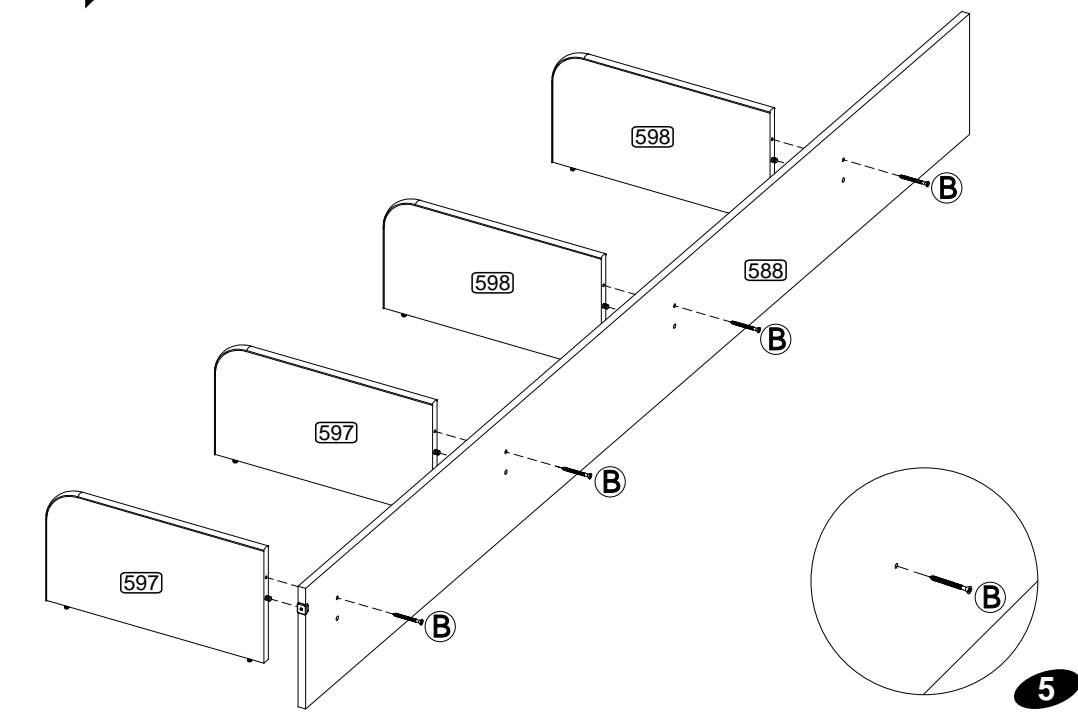

5