

AP04 - APARADOR

Manual de Montagem
Assembly Instructions
Instrucción de Montaje

decibal[®]
móveis

Produto Montado
Producto final
Assembled

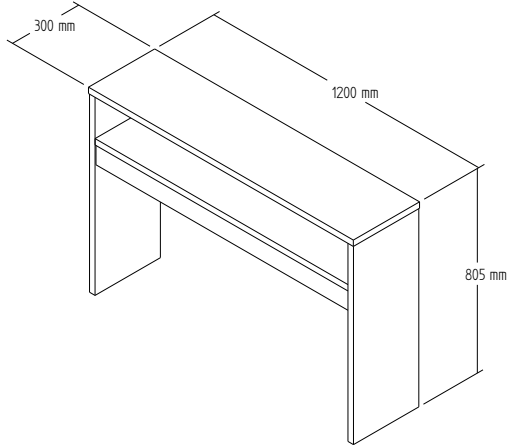

1º

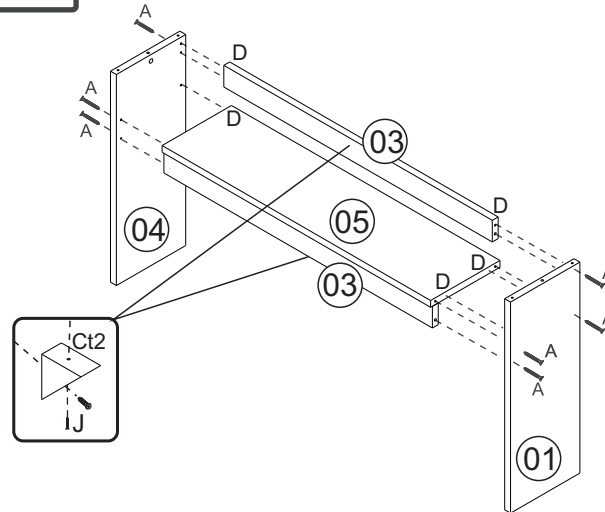

2º

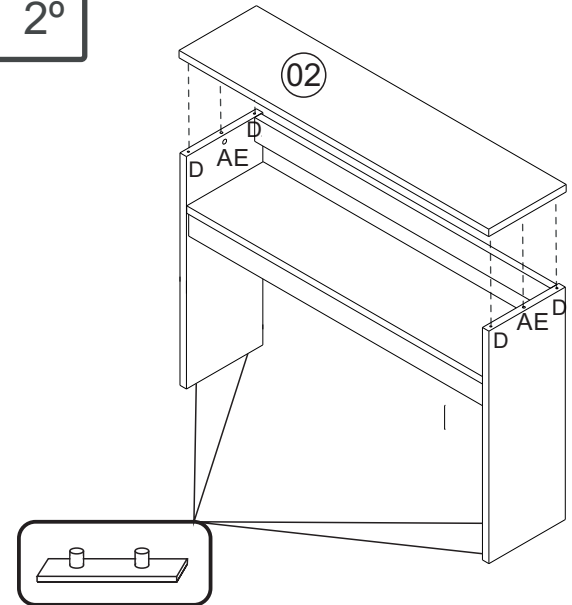

Relação de Peças/ Relación de Piezas/Parts List

Nº	CÓDIGO/CODE	DESCRIÇÃO/DESCRIPCIÓN/DESCRIPTION	QTD/CANT	VOL.
1	0512156	LATERAL/LATERAL/SIDE 780X296X25 MM P	1,00	1
2	0512155	TAMPO/TAPA/TOP 1200X300X25 MM	1,00	1
3	0512157	TRAVESSA/TRAVIESA/TRVERSE 1146X80X25 MM	2,00	1
4	0512159	LATERAL/LATERAL/SIDE 780X296X25 MM P	1,00	1
5	0512158	BASE 1146X296X25 MM	1,00	1

Ferramenta necessárias
Necessary tools
Herramientas necesarias

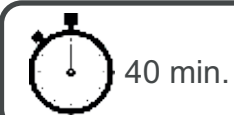

40 min.

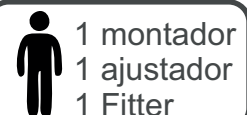

1 montador
1 ajustador
1 Fitter

www.decibal.com.br

ATENÇÃO montadores e consumidores:

* Para limpar o móvel utilize somente um pano úmido (umedecido em água pura ou água com sabão neutro). Depois, passe um pano seco. Evite a umidade excessiva.

* Evite usar álcool, água sanitária, detergente e outros produtos químicos, mesmo diluídos em água. Não utilize produtos abrasivos de nenhuma espécie para limpar o móvel. A utilização de tais produtos pode comprometer as características finais do móvel.

ATTENTION assemblers and consumers:

- To clean the furniture, use only a damp cloth (humidify it only in pure water or water and neutral soap). After, use a dry cloth. Avoid excessive humidity.







- Avoid using alcohol, bleach, detergent and other chemical products, even diluted in water. Do not use any kind of abrasive cleaning agents to clean the furniture. The use of such products may jeopardize the final characteristics of the furniture.

AP04 - APARADOR



Manual de Montagem
Assembly Instructions
Instrucción de Montaje

decibal[®]
móveis

escala (1:1)

LEGENDA	DESCRIÇÃO/DESCRIPCIÓN/DESCRIPTION	CÓDIGO	QUANT.
D	 CAVILHA/TARUGO/DOWEL 8X30 MM	01592	12
AE	 PARAFUSO/TORNILLO/SCREW MINIFIX TAMBOR/BOLT MINIFIX (HASTE SIMPLES)	01314	02
A	 PARAFUSO/TORNILLO/SCREW 6X70	08061	08
J	 PARAFUSO/TORNILLO/SCREW 4X16	01319	04
	 ADESIVO/ADHESIVO/ADHESIVE (CASTANHO)	07669	08
	 ADESIVO/ADHESIVO/ADHESIVE(ACACIA NATURE)	08064	08
	 ADESIVO/ADHESIVO/ADHESIVE(FREIJO NATURE)	08105	08

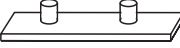
escala (N/A)

LEGENDA	DESCRIÇÃO/DESCRIPCIÓN/DESCRIPTION	CÓDIGO	QUANT.
K	 COLA/PEGAMENTO/GLUE	01213	01
SL	 SAPATA L 58X15 BR/ZAPATO L 58X15 BRC/SHOE L 58X15 BRG	08065	04
ET	 ETIQUETA LOGO DECIBAL/LABEL DECIBAL	01312	01
CT2	 CANTONEIRA/PIEZA L/METAL SHEET	04167	02

