

# SBRP 430 / SBRP 430 P

## Manual de Instruções do Suporte

### ATENÇÃO

Abra, identifique e conte todos os componentes deste suporte, utilizando o gabarito. Utilize uma superfície plana para separar e contar as peças.

#### Ferramentas requeridas:

Chave Philips média (não incluída) / 1 chave de boca 7/16" (não incluída) / 1 chave de boca de 1/2" (não incluída) / 2 chaves de boca 9/16" (não incluída).

## Instruções de Instalação

### ATENÇÃO

**1) Caso você não tenha afinidade para fazer a instalação, chame um profissional qualificado.**

**IMPORTANTE:** Se a instalação for realizada por um técnico, assegure-se de que o mesmo tenha lido as instruções de montagem. O desconhecimento das instruções pode levar à queda do suporte e dos aparelhos que estejam sustentados.

**2) SUPERFÍCIE DE INSTALAÇÃO:** Os acessórios incluídos são apropriados unicamente para fixação em paredes de alvenaria ou tetos de concreto, blocos de concreto, ladrilhos.

**IMPORTANTE:** Para paredes mais frágeis, por favor, consulte um profissional qualificado.

**3) LOCAL DE INSTALAÇÃO:** Deve-se evitar a instalação do suporte sobre camas, cadeiras ou similares.

**4) CUIDADO:** Afaste as crianças da área de trabalho durante a instalação e **NUNCA** permita que crianças manuseiem o equipamento.

**5) VERIFICAÇÃO DA INSTALAÇÃO DA TV:** Verifique se a TV está bem colocada e os parafusos de fixação bem apertados, para evitar a queda do aparelho.

**IMPORTANTE:** Se tiver alguma dúvida, quanto à segurança, recomenda-se procurar um profissional qualificado.

**6) MANUTENÇÃO:** Como todo produto regulável, faça o reaperto dos parafusos depois de uma semana de instalado e, posteriormente, a cada mês, verificando os seguintes itens:

- Se a placa de fixação na parede está bem aderida.
- Se o equipamento eletrônico está bem preso no suporte.
- Se os parafusos/porcas estão bem apertados.

## Wall Bracket Instruction Manual

### WARNING

Open, identify and count all hardware and parts. You should have everything on the hardware included list provided with these instructions.

Assemble them on a flat surface to assure that parts fit together squarely and flush; we recommend a carpeted surface. You may also use a bracket to prevent scratch of the piece during assembly process.

**Tools required:** Medium Philips screwdriver (not included) / 1 Wrench 7/16" (not included) / 1 Wrench 1/2" (not included) / 2 Wrenches 9/16" (not included).

## Installation Procedures and Instructions

**WARNING: WHEN INSTALLING THE BRACKET MAKE SURE TO FOLLOW THE INSTRUCTIONS THOROUGHLY!! FAILING TO DO SO MAY CAUSE BRACKET TO FALL AND EXTENSIVE DAMAGE NOT COVERED BY THE WARRANTY OF THIS PRODUCT.**

**1) If you are not familiar with the necessary procedures to install this type of product, call a qualified professional.**

**WARNING:** If installation is to be made by a professional, make sure this person reads the installation instruction. Ignoring instructions may cause the bracket and installed equipment to fall off.

**2) INSTALLATION SURFACES:** Included accessories are appropriate only for attachment to brick walls, concrete ceilings, concrete blocks, glazed tile, or drywall.

**WARNING:** For more fragile walls, please call a qualified professional.

**3) INSTALLATION PLACE: NEVER** install products above beds, cradles or similar locations.

**4) WARNING:** Keep products out of children's reach, and **NEVER** allow children to handle equipment or tools.

**5) CHECKING TV INSTALLATION:** Check if TV set is properly installed and that mounting screw are tight to ensure the TV set does not fall down.

**WARNING:** If you have any doubt concerning safety, please call a qualified professional.

**6) MAINTENANCE:** As with any adjustable product:

One week after first installed, make sure to check and retighten all nuts and bolts and monthly to:

- Make sure wall plate is firm and flush with wall.
- Make sure appliances are securely in place.
- Make sure all nuts and bolts are tight.

## Manual de Instrucciones del Soporte de Pared

### ATENCIÓN

Antes de usted empezar, abra, identifique y cuente todas las herramientas y piezas. Usted deberá tener todas herramientas incluídas en la lista anexa con estas instrucciones.

#### Herramientas requeridas:

Destornillador hoja cruciforme (no incluido) / Llave española 7/16" (11,11 mm) (no incluido) / Llave española 1/2" (12,7 mm) (no incluido) / 2 Llaves española 9/16" (14,29 mm) (no incluido).

## Instrucciones de Instalación

### ATENCIÓN:

**1) En caso que usted no tenga mucha afinidad para hacer la instalación, solicite un profesional calificado.**

**IMPORTANTE:** si la instalación fuera realizada por un técnico, asegúrese de que el mismo haya leído las instrucciones de seguridad. El desconocimiento de las instrucciones puede ocasionar la caída del soporte y de los equipos que estén sostenidos.

**2) SUPERFICIE DE INSTALACIÓN:** los accesorios incluídos son apropiados únicamente para la fijación en paredes de albañilería o techos de concreto, block de concreto, ladrillos.

**IMPORTANTE:** para paredes mas frágiles, por favor, consulte un técnico especializado.

**3) LUGAR DE INSTALACIÓN:** se debe evitar la instalación de soportes sobre las camas, sillas o semejantes.

**4) CUIDADO:** mantenga los niños apartados del área de trabajo durante la instalación y nunca permita que los niños manipulen las herramientas.

**5) VERIFICACIÓN DE LA INSTALACIÓN DE LA TV:** Verifique que el televisor esté bien colocado en el soporte y los tornillos de fijación bien apretados para evitar que se suelten.

**6) MANTENIMIENTO:** Como todo producto regulable, haga la revisión de los tornillos después de una semana de instalado y, posteriormente cada mes, verificando los siguientes accesorios: • Si la placa de fijación esta fuertemente adherida a la pared. • Si el equipo electrónico esta correctamente adherido al soporte. • Si los tornillos y tuercas están apretados.

## Montagem do Suporte / Wall Bracket Assembly / Montaje del Soporte

<b>A</b>		<b>3</b>	Bucha / Bushing / Taquetes $\phi$ 10,0 mm
<b>B</b>		<b>3</b>	Parafuso / Hex Head Screw / Tornillo Hexagonal 5/16" (7,93 mm) x 55 mm
<b>C</b>		<b>2</b>	Porca / Nut / Tuerca 3/8" (9,52 mm) X 9/16" (14,28 mm)
<b>D</b>		<b>1</b>	Parafuso Francês / Screw / Tornillo 5/16" (7,93 mm) X 3/4" (19,05 mm)
<b>E</b>		<b>1</b>	Parafuso / Screw / Tornillo 3/8" (9,52 mm) X 4" (101,6 mm)
<b>F</b>		<b>4</b>	Parafuso / Screw / Tornillo M4 x 16 mm
		<b>4</b>	Parafuso / Screw / Tornillo M5 x 20 mm
		<b>4</b>	Parafuso / Screw / Tornillo M6 x 20 mm
		<b>4</b>	Parafuso / Screw / Tornillo M8 x 15 mm
<b>G</b>		<b>1</b>	Parafuso / Screw / Tornillo 3/8" (9,52 mm) X 2 1/2" (63,5 mm)
<b>H</b>		<b>4</b>	Porca / Nut / Tuerca M5 x 8 mm
<b>I</b>		<b>4</b>	Arruela / Smooth Washer / Arandela Lisa 5,3 x 10 x 1 mm
<b>J</b>		<b>4</b>	Parafuso / Screw / Tornillo M5 x 8 mm
<b>K</b>		<b>1</b>	Porca / Nut With Constraint / Tuerca de Seguridad 5/16" (7,93 mm) X 1/2" (12,70 mm)
<b>L</b>		<b>2</b>	Ponteira / Plastic Cover / Cubierta Plástica 40 x 20 mm
<b>M</b>		<b>4</b>	Parafuso / Screw / Tornillo M5 x 12 mm
<b>N</b>		<b>4</b>	Arruela / Smooth Washer / Arandela Lisa 6,0 x 12 x 2 mm
<b>O</b>		<b>2</b>	Arruela / Smooth Washer / Arandela 10 x 25 mm
<b>P</b>		<b>2</b>	Espaçador / Spacer / Espaçador 20 x 19.5 mm
<b>Q</b>		<b>4</b>	Porca / Nut / Tuerca M5
<b>R</b>		<b>2</b>	Bucha / Bushing / Taquetes $\phi$ 8,0 mm
<b>S</b>		<b>2</b>	Parafuso / Screw / Tornillo 1/4" x 40 mm
<b>T</b>		<b>2</b>	Arruela / Smooth Washer / Arandela Lisa 8,5 x 17 x 2 mm

### Total 64

<b>P1</b>		<b>1</b>	Base / Base / Base
<b>P2</b>		<b>1</b>	Braço / Arm / Brazo
<b>P3</b>		<b>1</b>	Capa Plástica / Plastic Cover / Capa de Plástico
<b>P4</b>		<b>1</b>	Base do Vesa / Vesa Base / Base do Vesa
<b>P5</b>		<b>1</b>	Suporte do Vesa / Bracket Vesa / Soporte de Vesa
<b>P6</b>		<b>2</b>	Braço Vertical / Arm Vertical / Brazo Vertical
<b>P7</b>		<b>2</b>	Braço Horizontal / Horizontal Arm / Brazo Horizontal
<b>P8</b>		<b>2</b>	Suporte do Vídeo / Bracket Video / Soporte do Vídeo
<b>P9</b>		<b>2</b>	Capa / Cover / Capa

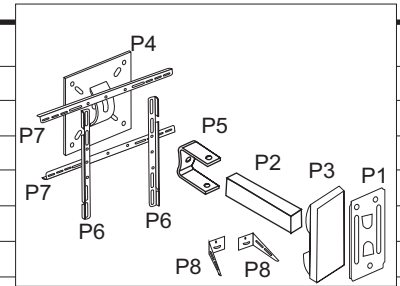

### Total 13

1) Para aplicação em **parede maciça**, a maior resistência deverá ocorrer entre a primeira e a quinta volta após encostar a cabeça do parafuso na chapa.

1) For **concret wall** application, the highest strength shall occur between the first and fifth thread of the screw, when the screwhead is flush to the bracket plate.

1) Para instalación en **pared maciza**, la mayor resistencia tendrá que ocurrir entre la primera y la quinta vuelta después que el tornillo apoye en la placa.

Nível  
Check level  
Nivelar

1/4" = 6 mm

3/8" = 8,0 mm

13 mm = 1/2"

**ATENÇÃO**  
**WARNING**  
**ATENCIÓN**

  
**40 kg = 88 lb**

Não exceder o peso e as dimensões especificadas.  
Do not exceed the maximum specified weight and dimensions.  
No exceda el peso y dimensiones máximos especificados.

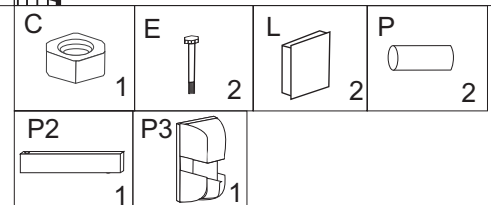

**6**

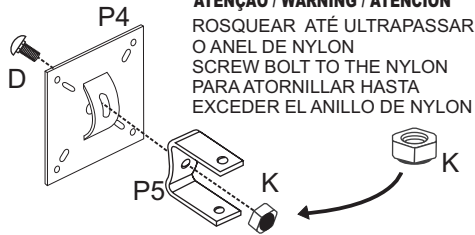

**ATENÇÃO / WARNING / ATENCIÓN**  
 ROSQUEAR ATÉ ULTRAPASSAR O ANEL DE NYLON  
 SCREW BOLT TO THE NYLON RING UNTIL IT EXCEEDS THE NYLON RING  
 PARA ATORNILLAR HASTA EXCEDER EL ANILLO DE NYLON

**7**

Utilize uma das 4 opções oferecidas (F), conforme a furação da sua TV.

Use one of the 4 available options (F), according to the holes on your TV set.

Utilice una de las 4 opciones (F), ofrecidas conforme la perforación de su TV.

**8**

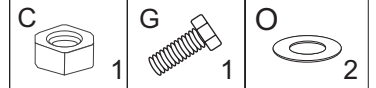
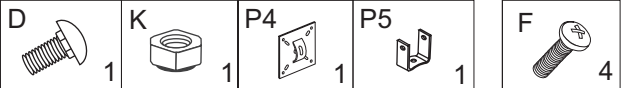
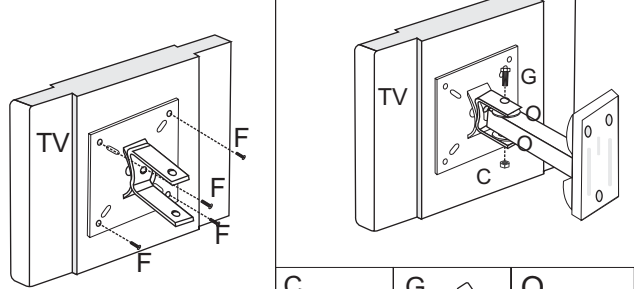

**1**

PARA TV VESA ATÉ 600 x 400  
 FOR TV VESA UNTIL 600 x 400  
 PARA TV VESA HASTA 600 x 400

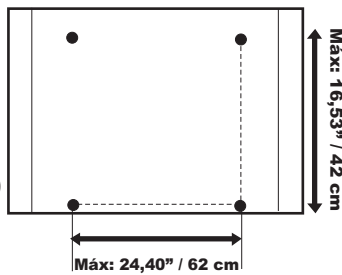

**2**

PARA TV VESA ATÉ 600 x 100  
 FOR TV VESA UNTIL 600 x 100  
 PARA TV VESA HASTA 600 x 100

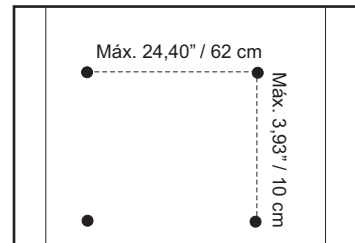

**1.1**

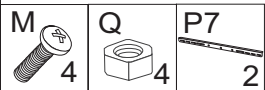
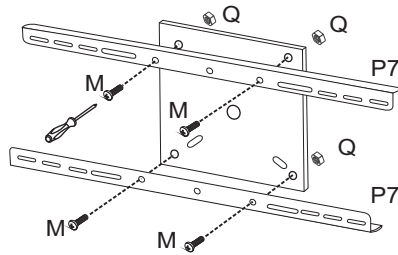

**2.1**

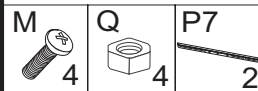
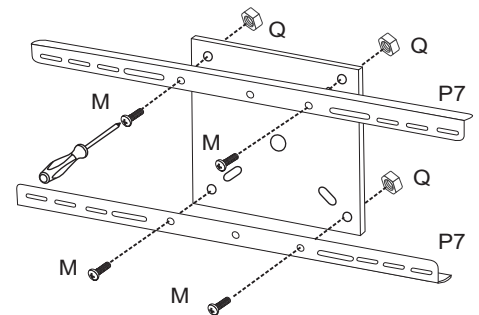

**1.2**

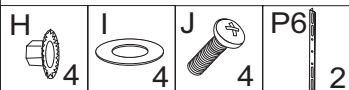
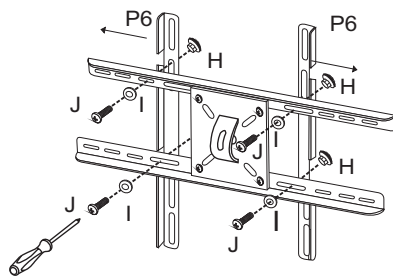

**2.2**

Utilize uma das 4 opções oferecidas (F), conforme a furação da sua TV.

Use one of the 4 available options (F), according to the holes on your TV set.

Utilice una de las 4 opciones (F), ofrecidas conforme la perforación de su TV.

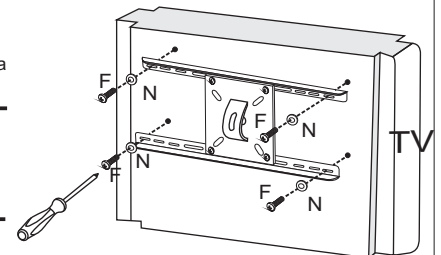

**1.3**

Utilize uma das 4 opções oferecidas (F), conforme a furação da sua TV.

Use one of the 4 available options (F), according to the holes on your TV set.

Utilice una de las 4 opciones (F), ofrecidas conforme la perforación de su TV.

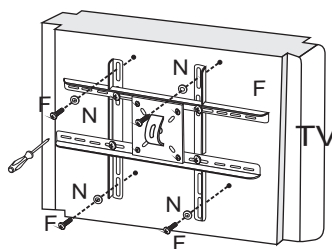

## Montagem do Suporte de DVD / DVD Bracket Installation / Montagen del Soporte del DVD

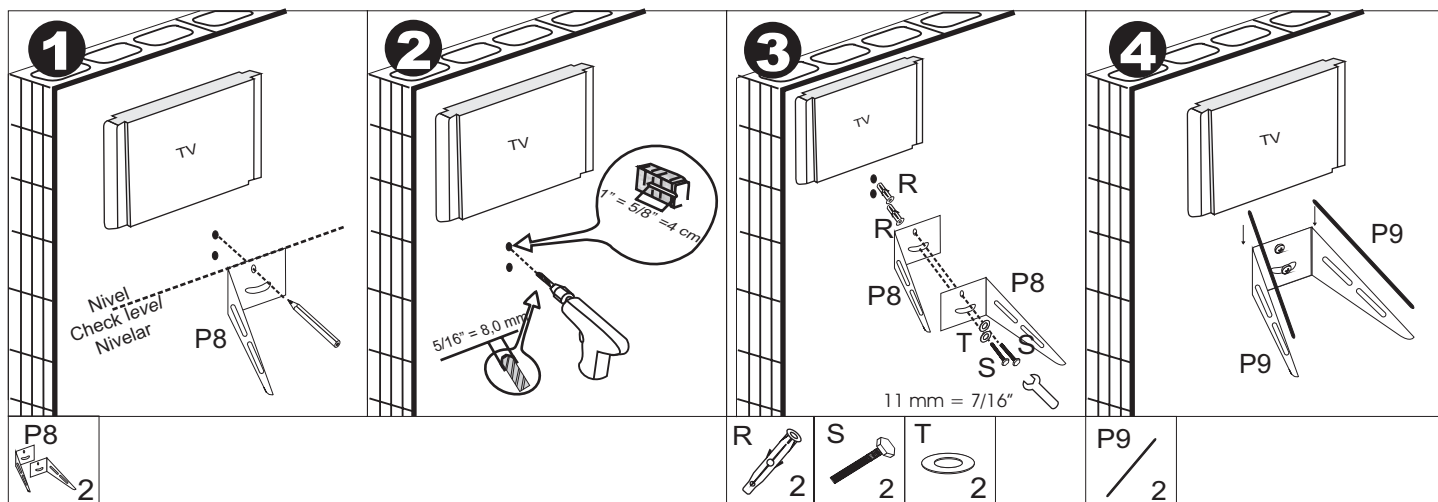

### Termo de Garantia

A garantia total cobre defeitos de fabricação, material, peças e a respectiva mão de obra para o conserto, após a devida comprovação pelos técnicos credenciados.

A garantia será nula se o produto sofrer danos resultantes de acidente, montagem incorreta, uso indevido, descuido, ação de agentes corrosivos, carga excessiva, parafusos ou porcas mal apertadas, desconhecimento das instruções contidas no Manual de Instruções ou se apresentar sinais de haver sido reparado por pessoas não autorizadas.

O comprador será responsável pelas despesas de transporte e embalagem até o Serviço Autorizado mais próximo. Esta garantia é intransferível e válida somente mediante a apresentação da Nota Fiscal de compra. Este produto está sujeito a modificações técnicas e de desenho para seu aprimoramento sem aviso prévio do fabricante

### Warranty Terms

This product is warranted to the original retail purchaser as follows:

You must retain the original sales receipt showing purchase date and terms of sale.

**WARRANTY:** When purchased from an authorized dealer, this product is warranted against defective materials or workmanship of useful life, based on reasonable use. Your exclusive remedy for this Warranty is that The manufacturer will, at its option and within a reasonable amount of time, repair, or replace this product or refund the original purchase price of this product. This option makes this a limited warranty. To make claim under this warranty, you must contact the authorized dealer from whom the product was purchased, or if you cannot locate the authorized dealer, contact: suporte@brasforma.com.br. The manufacturer reserves the right to discontinue or change parts, models, and products or to make substitutions.

**WARRANTY LIMITATIONS:** This warranty does not include:

- Any condition resulting from incorrect assembly or inadequate maintenance, cleaning, or care, or commercial use.
  - Any condition resulting from other than ordinary residential wear and tear or from any use for which the product was not designed.
  - The use of this product for rental use or for use in business or institutions or other heavy duty applications.
  - The matching of color, grain, or texture of wood.
  - The use of this product by an unattended child or disabled person. This warranty does not cover damage from transportation by a common carrier.
- Under no conditions is the manufacturer liable for any of the following: loss/fall and/or damage to TV's, electronic devices, a computer; loss of or damage to programs, records or data; and consequential or incidental damages, even if informed of their possibility.

**LIMITATIONS OF DAMAGES:** THE WARRANTIES AND REMEDIES SET FORTH ARE EXCLUSIVE AND IN LIEU OF ALL OTHERS, ORAL, WRITTEN, EXPRESS OR IMPLIED, IN NO EVENT WILL BRASFORMA BE LIABLE TO YOU FOR ANY DAMAGES, INCLUDING INCIDENTAL OR CONSEQUENTIAL DAMAGES, ARISING OUT OF THE USE OR INABILITY TO USE THIS PRODUCT.

**LIMITATION OF WARRANTIES AND OTHER WARRANTY TERMS AND STATE LAW RIGHTS,** ANY IMPLIED WARRANTIES, INCLUDING IMPLIED WARRANTIES FOR MERCHANTABILITY AND FITNESS FOR A PARTICULAR PURPOSE, SHALL BE LIMITED TO THE DURATION AND TERMS OF THIS EXPRESS WRITTEN WARRANTY.

This warranty gives you specific legal rights, and you may also have other rights which vary from state to state. The manufacturer does not authorize any person to create for it any other warranty, obligations, or liability in connection with this product.

**DISCLAIMER OF DAMAGES** The remedies provided herein are BUYER'S sole and exclusive remedies and in no event shall SELLER be liable for direct, indirect, special, incidental, or consequential damages (including loss of profits) whether based on contract, tort, or any other legal theory.

### Condiciones de la Garantía

La garantía total cubre defectos de fabricación, material y piezas luego de la debida comprobación por parte de los técnicos. La garantía será nula si el producto sufre daños resultantes de accidentes, instalación deficiente, defectos causados por tornillos o tuercas sueltas, uso indebido, descuido, acción de agentes corrosivos, carga excesiva, desconocimiento de las instrucciones especificadas en el manual correspondiente o ante la presencia de señales de reparación por parte de personal no autorizado. Esta garantía es intransferible y válida solamente con la presentación de la factura de compra. El producto podrá sufrir modificaciones técnicas de diseño sin previo aviso del fabricante.

Produto Brasileiro

**BRASFORMA CHILE LTDA.**  
Muñoz Gamero, 958 - Recoleta - Santiago - Chile  
**Servicio Técnico y Servicio de Instalación:**  
☎ 56 - 2 - 629-1791 / 621-2305

Produto Brasileiro

**BRASFORMA IND. E COM. LTDA**  
Av. Henry Ford, 732 - Moóca  
São Paulo -Brasil  
**Orientação para montagem:** ☎ 55 11 2246-0222