

MANUAL DE MONTAGEM

ATENÇÃO:

- 1 - Ler atentamente todo o manual antes de iniciar a montagem do móvel.
- 2 - A montagem deve ser feita em uma superfície plana e limpa.
- 3 - Recomenda-se utilizar a embalagem do móvel para forrar e chão e assim não danificá-los

LIMPEZA E CONSERVAÇÃO:

A limpeza do móvel deve ser feita com utilização de pano umedecido com água, podendo conter uma pequena quantidade de álcool. Não utilize produtos abrasivos.

GARANTIA:

90 dias para defeitos de fabricação.

Quantidade de pessoas
necessárias para montar o
móvel

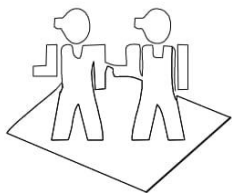







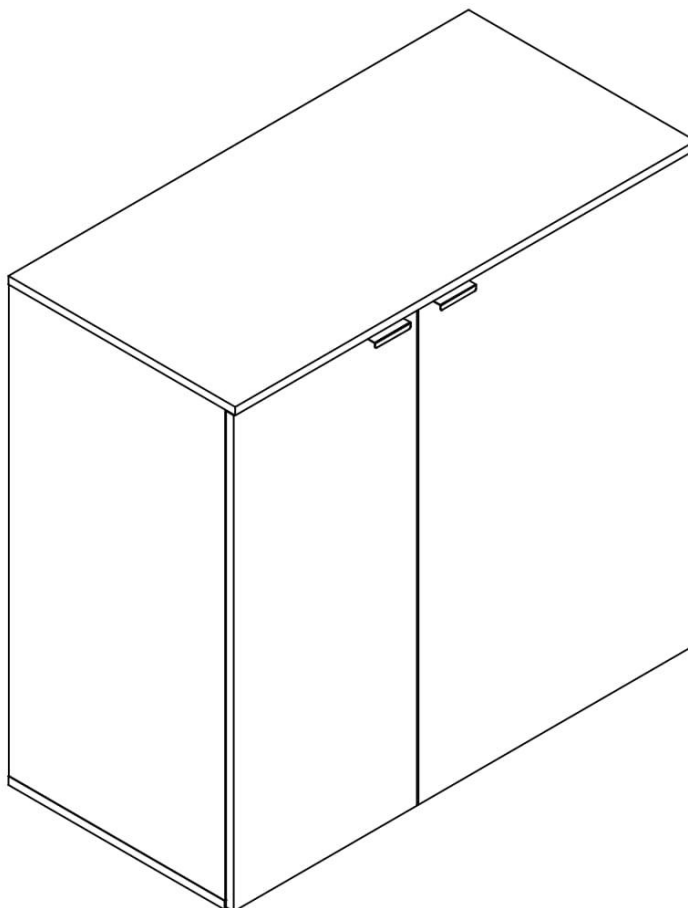
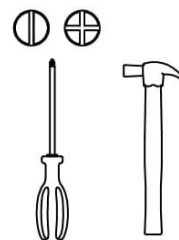



Tempo necessário para a
montagem: 2h









Ferramentas necessárias

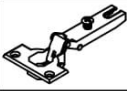

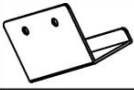
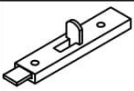
Lista de peças						
Código de assistência	Descrição	Quant.	Compr. (mm)	Larg. (mm)	Espes. (mm)	Caixa/ volume
01	Lateral direita	1	838	426	15	A
02	Lateral esquerda	1	838	426	15	A
03	Tampo	1	907	447	15	A
04	Base	1	907	426	15	A
05	Prateleira	1	875	384	15	A
06	Travessa	1	875	76	15	A
07	Costa	1	875	838	15	A
08	Porta menor	1	361	846	15	A
09	Porta maior	1	537	846	15	A

Ferragem			
	Código de assistência	Descrição	Quant.
A	30945	 Minifix (parafuso)	12
B	30950	 Minifix (tambor)	12
C	14855	 Tampa para minifix Carvalle	12
D	1802	 Cavilha 6x30mm	20
E	58	 Etiqueta marca "Kappesberg"	1
F	41	 Cola branca em bisnaga (10g)	1
G	4214	 Parafuso chato 3,5x14 cabeça rebaixada	20
H	226	 Parafuso chato 4,0x40 bicromatizado	6
I	10109	 Chave allen 6mm	1
J	10102	 Bucha americana 1/4 x 10	6

K	10101	 Sapata regulável 1/4 x10	6
L	7787	 Dobradiça reta 35	4
M	7787	 Calço para dobradiça	4
N	7787	 Parafuso panela 4,0x14 para dobradiça	16
O	39999	 Puxador de chapa J preto fosco	2
P	1621	 Fecho zincado amarelo	1
Q	1622	 "L" de engate	1
R	1620	 Fechadura com chave	1
S	1178	 Parafuso flange 3,5x16 bicromatizado	2
T	899	 Cantoneira de metal	3



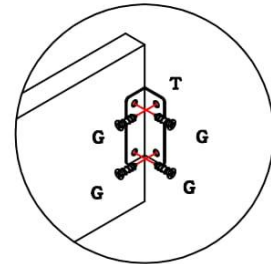
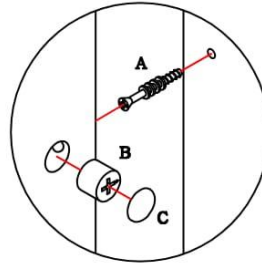
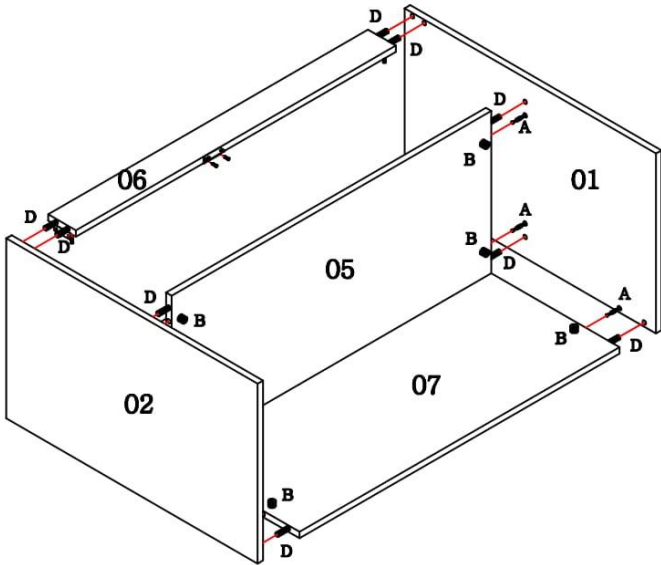

Utilize a cantoneira de metal "T" para fixar o sarrafo das portas nas laterais e no tampo.

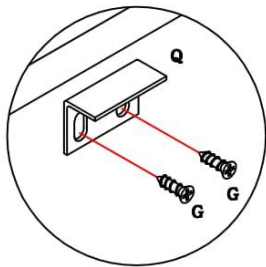

O L de engate "Q" para o fecho é colocado com o parafuso "G" no sarrafo das portas.

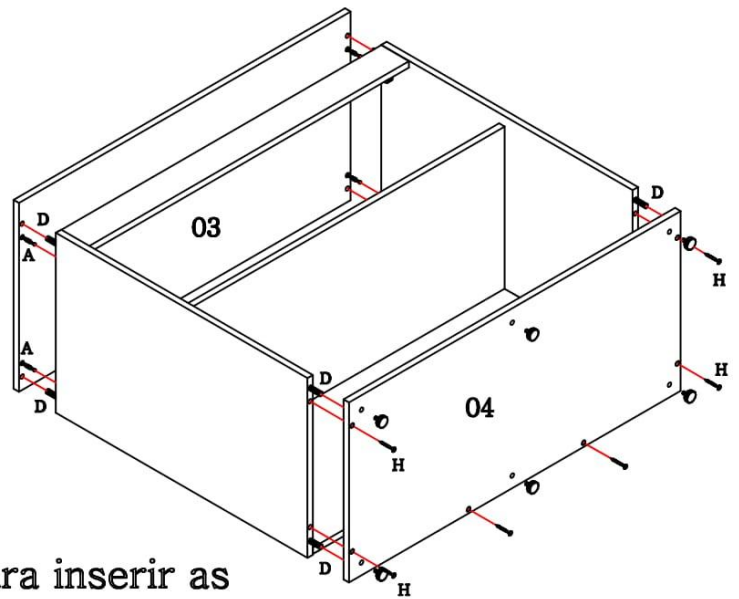

Utilize a chave allen "I" para inserir as buchas americanas na base, para em seguida colocar as sapatas reguláveis "K".

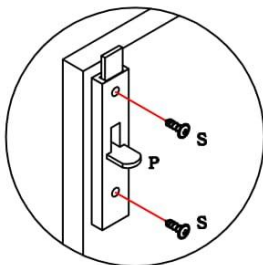

Fixe o fecho "P" na porta sem chave com o parafuso "S".

