





Acessórios

 Paraf. Ø4.5x45 mm
Montagem estrutura 8

 Par. Ø4x25 mm
Puxador / Montante e
União de módulos 7

 Par. Ø4x13 mm
P/dobradiça-calço 8

 Cavilha Ø8x30 mm
Montagem estrutura 8

 Ø26mm
Dobradiça RETA
Portas 2

 Calço baixo
Laterais 2

 Puxador Cromado 1

 Pistão a gás...60 N 1

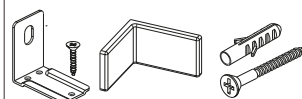
 Kit Suporte aéreo
c/ capa contendo
cada kit:

06 paraf. Ø4 x 13mm
02 paraf. Ø6 x 60mm
02 bucha Ø8mm

 Prego 10 x 10
Fundos 15

 Cola branca(sache)
P/cavilhas 1

Montagem da Estrutura

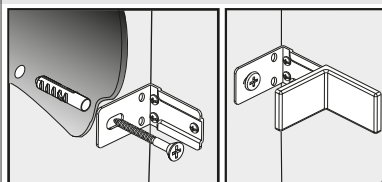

Fixe a cantoneira (suporte) **NAS LATERAIS**.
Posicione o módulo e através das cantoneiras,
fixe na parede com bucha e parafuso.

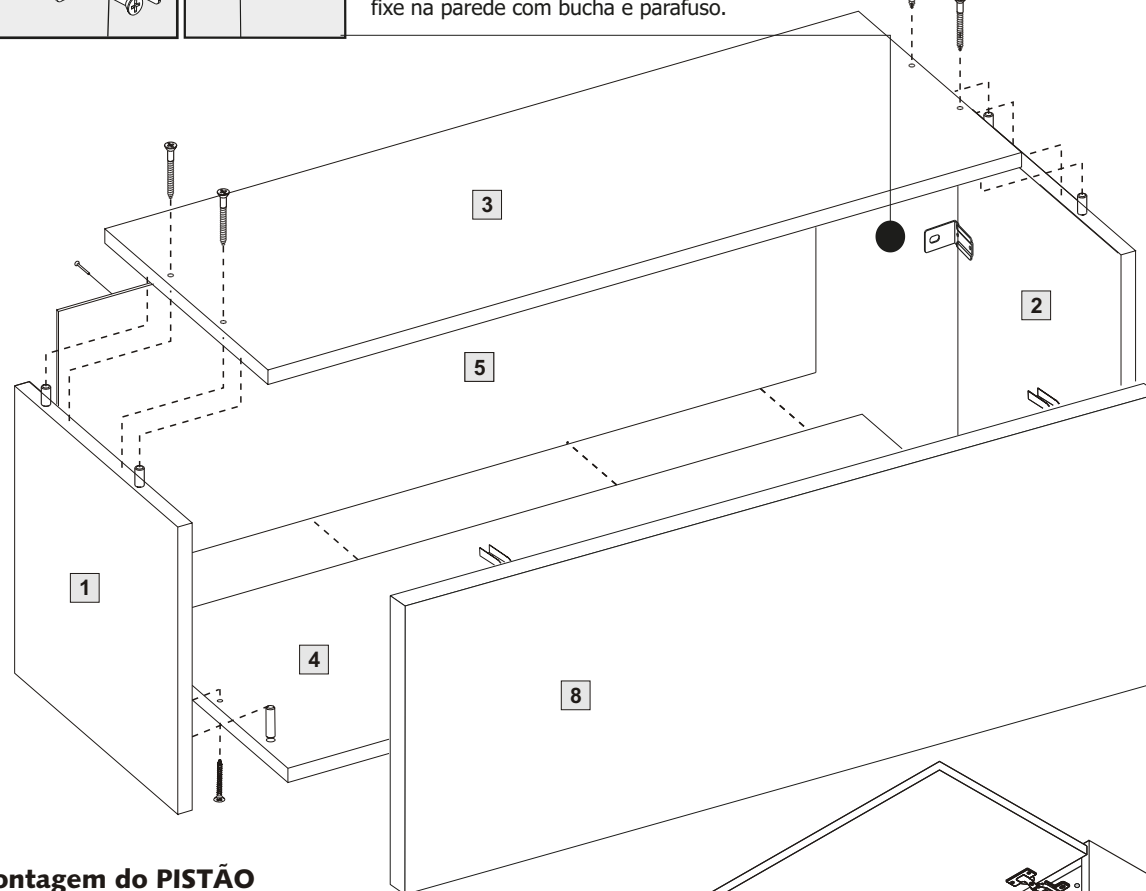

Montagem do PISTÃO

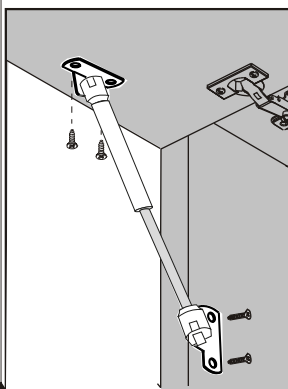

Montagem da Porta

1º Fixar o montante do calção
no chapéu do armário, com
parafusos 3.5x25 cab.
Flangeada.

2º Colocar os calços e fixar a
porta.

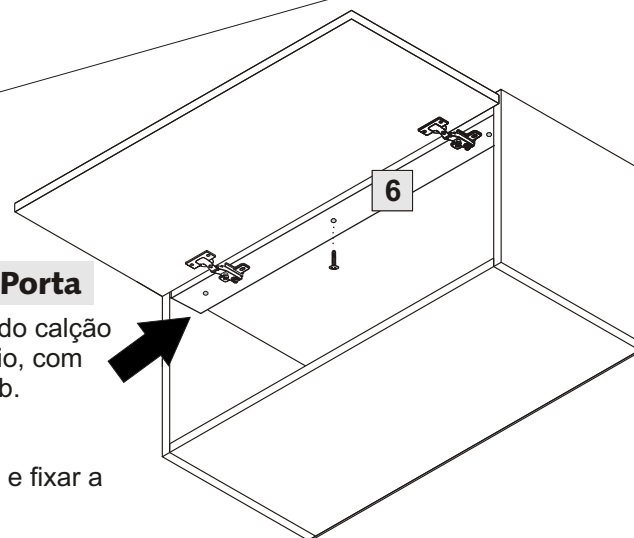

Armário Sup. 70x32cm 1p basc.

Larg.: 700mm Alt.: 320mm Prof.: 300mm

LINHA SMART UV

Cód. 414

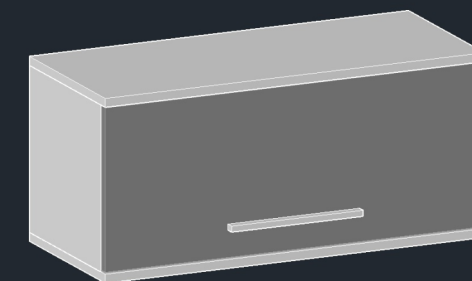

Item	Componente	QT.	ALT. X LARG.	Assist.Técnica
01	Lateral Dir.	01	290 x 280	
02	Lateral Esq.	01	290 x 280	
04	Base	01	300 x 700	
05	Chapéu	01	300 x 700	
06	Montante dobradiças	01	670 x 62	
07	Fundo traseiro	01	306 x 686	
08	Porta	01	285 x 695	