

REF. 5070 -KIT PÉS

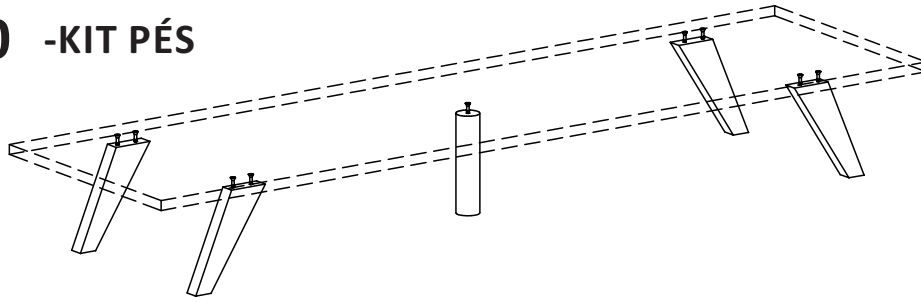

LISTA DE PEÇAS

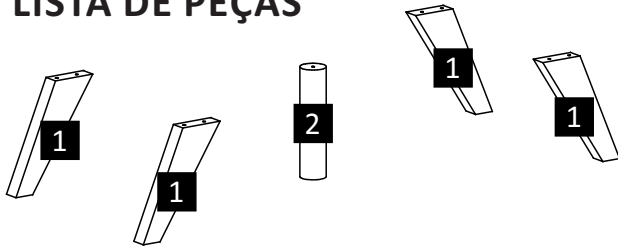

Item	Peças	Dimensões	Material	Qde
1	PÉ MADEIRA	22 X 60 X 150	MAD	4
2	PÉ CENTRAL	Ø35 X 150	MAD	1

TABELA DE ACESSÓRIOS



FERRAMENTAS



**PESSOAS
NECESSÁRIAS
PARA A
MONTAGEM**



Passo 1 | Fixação Pés Laterais

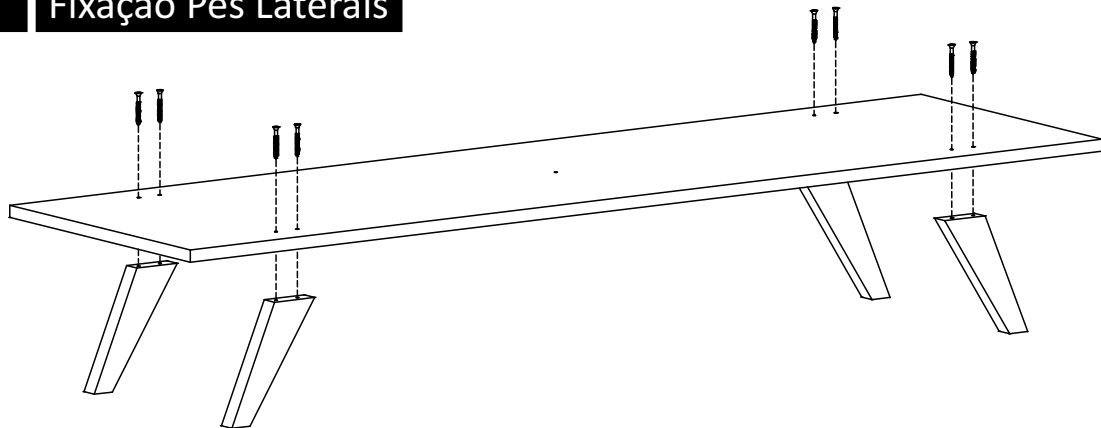

Posicionar Gabarito (pág 2) nos cantos da peça

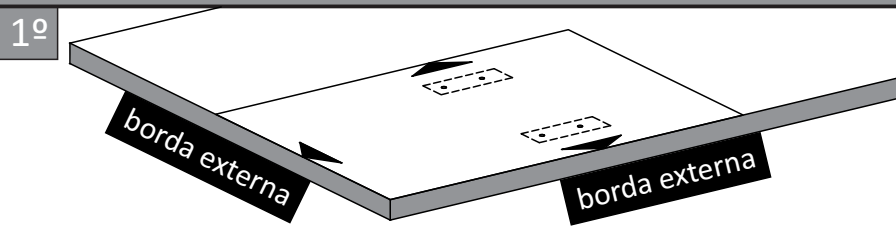

Medidas finais

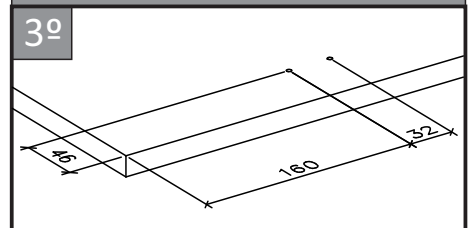

Fazer furações seguindo orientações do gabarito

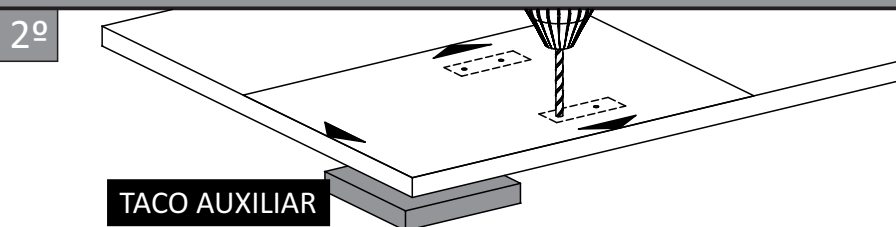

Fixar pés laterais

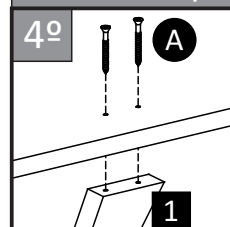

ATENÇÃO: PARA CORRETA UTILIZAÇÃO DESTES GABARITOS, DEVE-SE OBRIGATORIAMENTE POSICIONAR AS BORDAS DESTA PÁGINA, INDICADAS PELAS SETAS PRETAS, ALINHADAS COM AS BORDAS DA PEÇA, CONFORME MOSTRADO NO PASSO 01 ANTERIOR.

Alinhar com a borda da peça

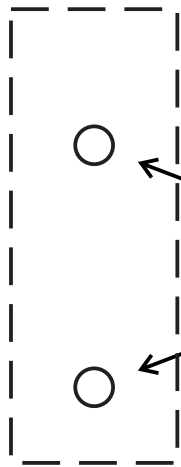

broca $\varnothing 3.5\text{mm}$
ou
broca $\varnothing 4\text{mm}$

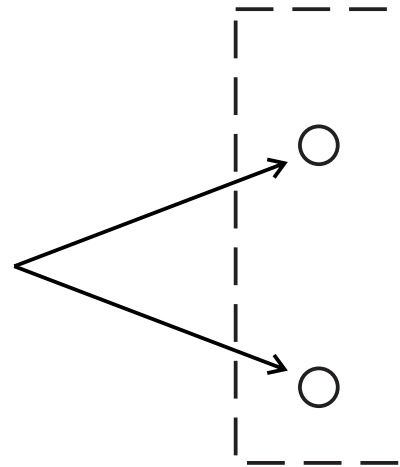

Alinhar com a borda da peça

Passo 2 * Somente para Pé Central

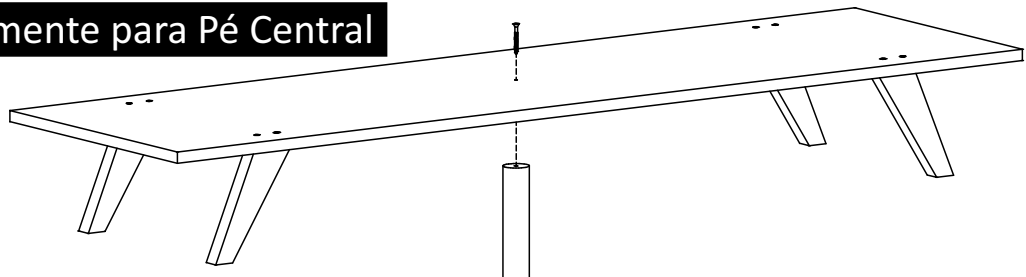

Marcar o centro da peça (comprimento)

1º

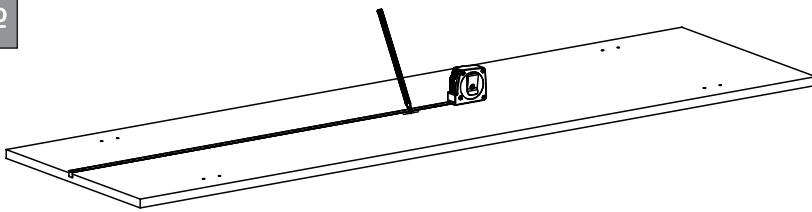

Marcar o centro da peça (profundidade)

2º

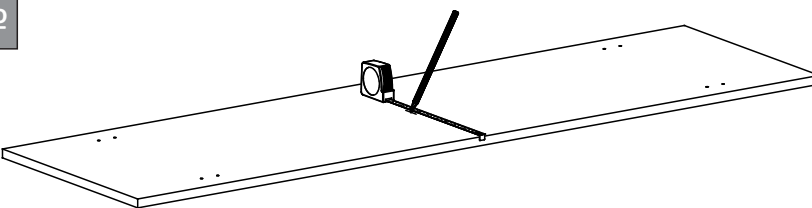

Furar peça (broca $\varnothing 3,5$ ou 4mm)

3º

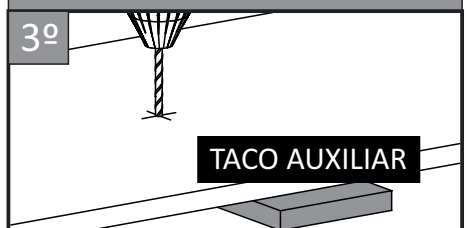

Fixar pé central

4º

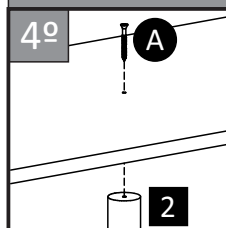

Alinhar com a borda da peça