

3081 3081/D- PANELEIRO

Manual de Montagem
 Assembly Instructions
 Instrucción de Montaje

Produto Montado
 Producto final
 Assembled

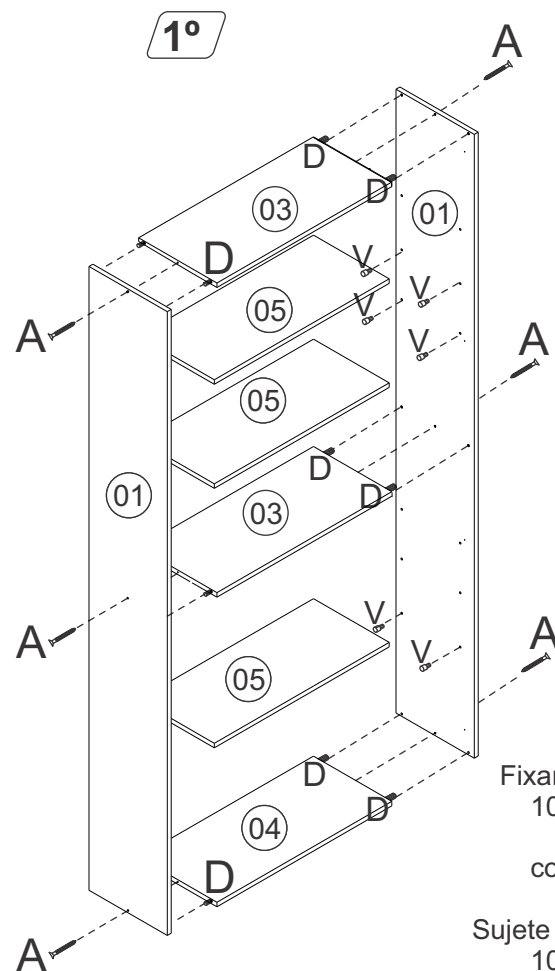
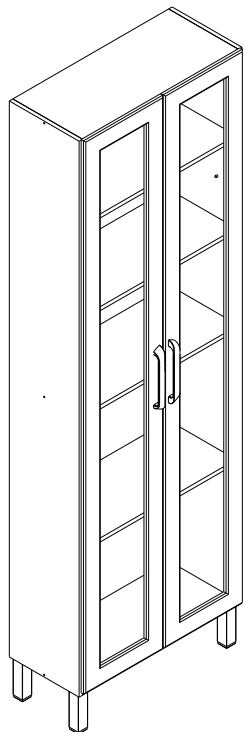

COSTAS :
 Fixar com pregos
 10X10 (01330)
 e fixador de
 costas (01331)

Sujete con las uñas
 10X10 (01330)
 y el sujetador
 trasera (01,331)



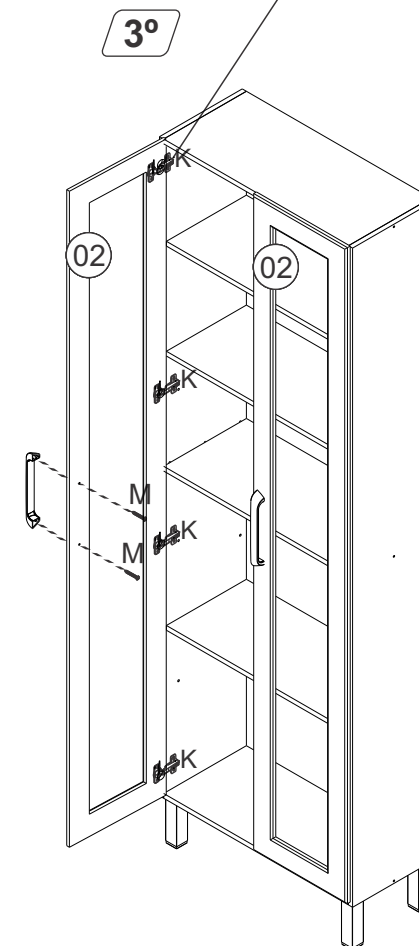
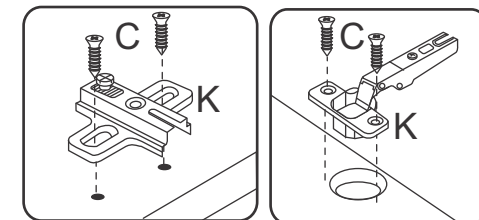
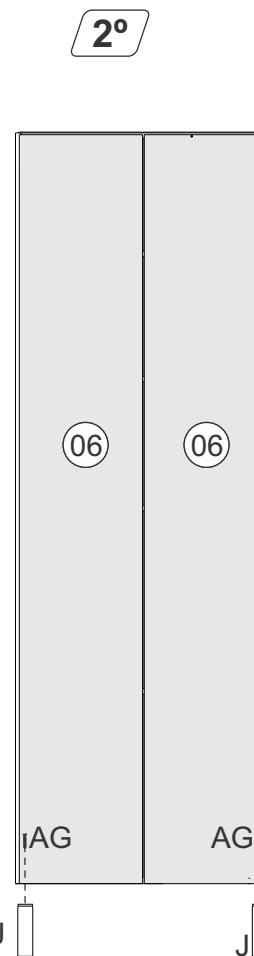







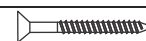

Fasten with nails
 10X10 (01330)
 and fastener
 back (01331)

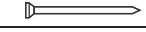

Relação de Peças/ Relación de Piezas/Parts List

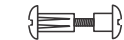
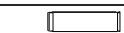
Nº	CÓDIGO/CODE	DESCRIÇÃO/DESCRIPCIÓN/DESCRIPTION	QTD/CANT	VOL.
1	0508410	LATERAL/LATERAL/SIDE 2070X300X15 MM P	2,00	1
2	0508415	PORTA/PUERTA/DOOR 2060X340X18 MM P	2,00	1
3	0508411	BASE 320X300X15 MM P	2,00	1
4	0508888	BASE 497X370X15 MM P	1,00	1
5	0508413	PRATELEIRA/ESTANTE/SHELF 320X290X15 MM P	3,00	1
6	0508414	COSTA/REVÊS/BACK 2065X340X3,2 MM P	2,00	1

Ferragens/ Herrajes/ Hardware

Nº	CODIGO/CODE	DESCRIÇÃO/DESCRIPCIÓN/DESCRIPTION	QUANT/CANT	FIGURA/FIGURE	
A	01318	PARAFUSO/TORNILLO/SCREW 4X45	6,00		
B	01328	PARAFUSO/TORNILLO/SCREW 3,5X12	16,00		
C	01319	PARAFUSO/TORNILLO/SCREW 4X16	16,00		
D	01211	CAVILHA/TARUGO/DOWEL 6X30 MM	14,00		
F	01213	COLA/PEGAMENTO/GLUE	1,00		
H	01330	PREGO/CLAVO/NAIL 10X10	75,00		
K	01268	DOBRADIÇA/BISAGRA/HINGE	8,00		
M	03130	PARAFUSO/TORNILLO/SCREW 3,5X25	4,00		
P	3081/D 06430	3081 04117	PUXADOR/TIRADOR/HANDLE	2,00	
AC	01495	PARAFUSO DE UNIÃO/TORNILLO PARA UNIÓN BOLT FOR UNION	2,00		
J	04116	PÉ/TORNILLO/FOOT	4,00		
AG	01320	PARAFUSO/TORNILLO/SCREW 5,0X45	4,00		
V	01368	SUPORE PRATELEIRA/SOPORTE ESTANTE/ SHELF SUPPORT	12,00		
	03772	ADESIVO/ADHESIVO/ADHESIVE	6,00		
	01312	ETIQUETA LOGO DECIBAL/LABEL DECIBAL	1,00		

ATENÇÃO!!!! montadores e consumidores

* Para limpar o móveis utilize somente um pano úmido (umedecido em água pura ou água com sabão neutro). Depois, passe um pano seco. Evite a umidade excessiva.

* Evite usar álcool, água sanitária, detergente e outros produtos químicos, mesmo diluídos em água. Não utilize produtos abrasivos de nenhuma espécie

ATENCIÓN!!!! montadores e consumidores

* Para limpiar el mueble utilice solamente un paño húmedo (humedecido con agua limpia o con un jabón suave).

A continuación, utilice un paño seco. Evite el exceso de humedad.

* Evite uso de alcohol, hipoclorídido solución basada, detergente y otros productos químicos, mismo diluídos en agua. No utilice productos abrasivos de ningún tipo.

ATTENTION!!!! assemblers and consumers

* To clean the furniture, use only a damp cloth (humidify it only in pure water ou water and neutral soap). After, use a dry cloth. Avoid excessive humidity.

* Avoid using alcohol, bleach, detergent and other chemical products, even diluted in water. Do not use any kind of abrasive cleaning agents to clean the furniture.

The use of such products may jeopardize the final characteristics of the furniture.