

Peso distribuido
de maneira
uniforme

Peso distribuido
de maneira
uniforme

Distributed
weight so
uniform

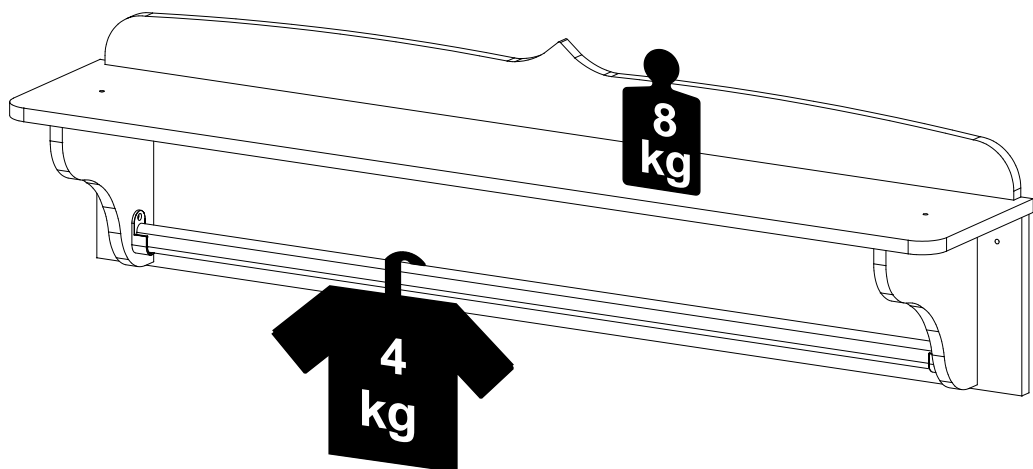

INSTRUÇÕES DE MONTAGEM
INSTRUCCIONES DE ARMADO
ASSEMBLY INSTRUCTIONS



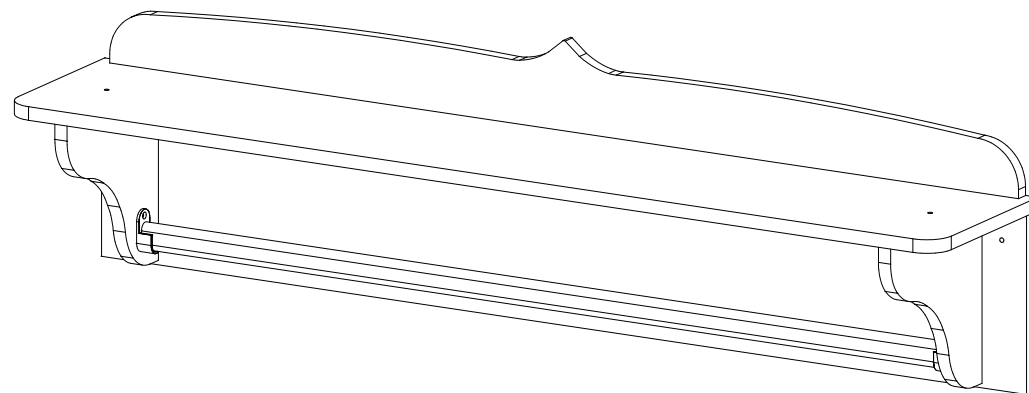



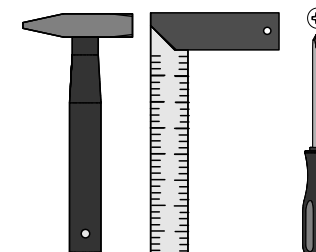
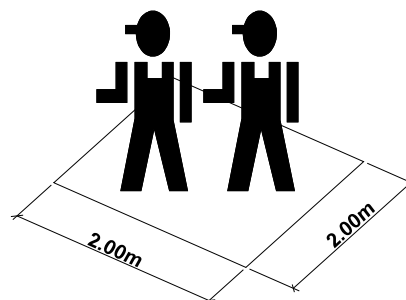

REF.: 2354

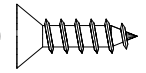

MULTIMÓVEIS
baby

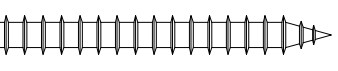
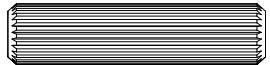
Rua Carlos Dreher Neto, 1918, Fone: (54) 2102 4000, FAX: (54) 2102 4050
CEP 95700-000 - BENTO GONÇALVES - RS - BRASIL
CNPJ: 00.349.443/0001-92
e-mail: multimoveis@multimoveis.com / site: www.multimoveis.com

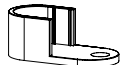
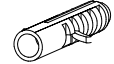

B	  4,5 x 50	07
E	  3,5 x 14	04
D	  4,8 X 45	02
H	 8,0 x 30	08
J	 8,0 x 50	02
K	 Tampa CPL	02
W		02
BU	 Bucha plástica 8mm	02
BX	 COLA	01
ED	 Tampa Adesiva Papel	02

Utilizar a régua abaixo para medir as ferragens:

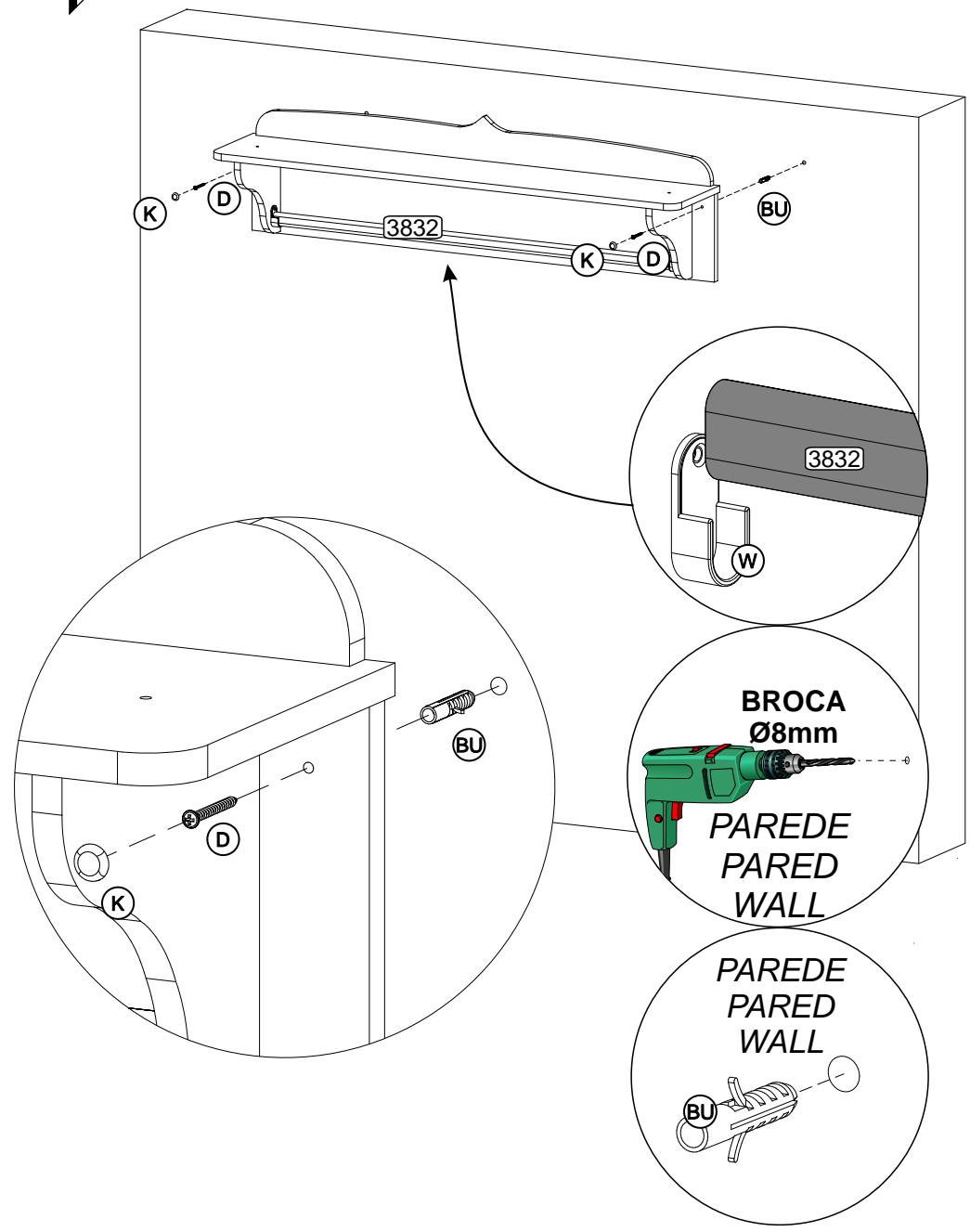

Passo
Paso
Step
02

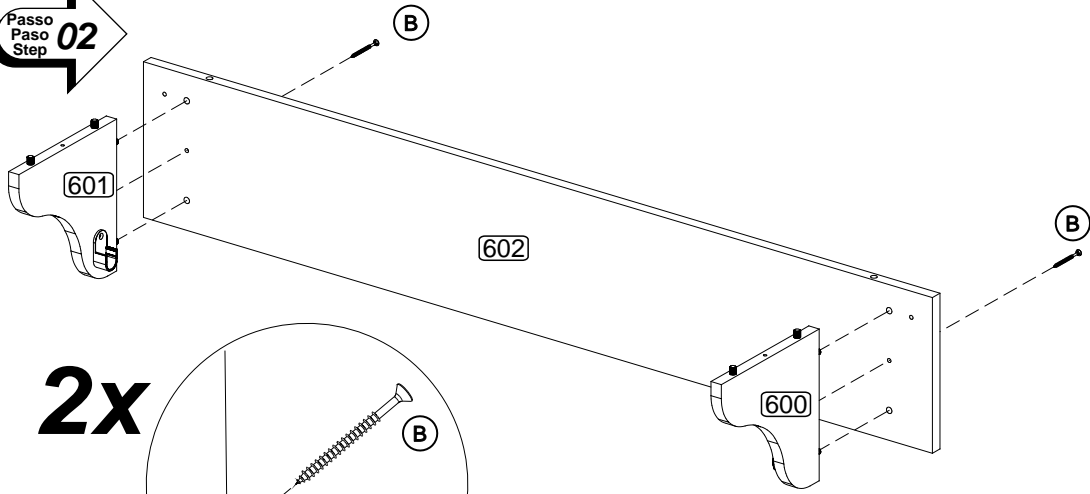

2x

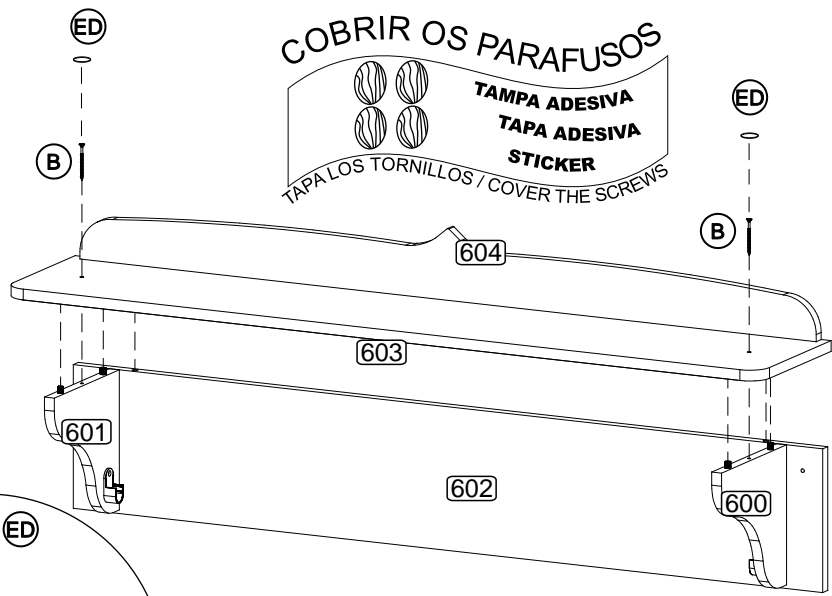

Passo
Paso
Step
03

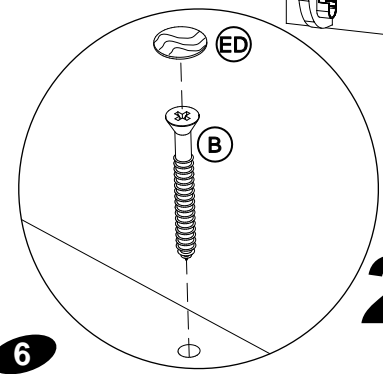

COBRIR OS PARAFUSOS
TAPA ADESIVA
TAPA ADESIVA
STICKER
TAPA LOS TORNILLOS / COVER THE SCREWS



2x

Senhor montador!
Informamos que a numeração das peças encontra-se no topo das mesmas conforme desenho acima.

Señor Armador!
Les informamos que la numeración de las piezas encuentranse arriba de las mismas, de acuerdo al modelo arriba.

Dear Assembler!
We inform you that the number of each piece is located on the top of it, according to the model shown above.



POR

LISTA DE PEÇAS

- N°**
- 600 - LATERAL DIREITA
 - 601 - LATERAL ESQUERDA
 - 602 - COSTA
 - 603 - TAMPO
 - 604 - MOLDURA
 - 3832 - CABIDEIRO

ESP

LISTA DE PIEZAS

- N°**
- 600 - LATERAL DERECHA
 - 601 - LATERAL IZQUIERDA
 - 602 - RESPALDO
 - 603 - TAPA
 - 604 - MOLDURA
 - 3832 - PERCHA

ENG

PART LIST

- N°**
- 600 - RIGHT SIDE
 - 601 - LEFT SIDE
 - 602 - BACK
 - 603 - TOP
 - 604 - FRAME
 - 3832 - HANGER

