

Passo
Paso
Step
11

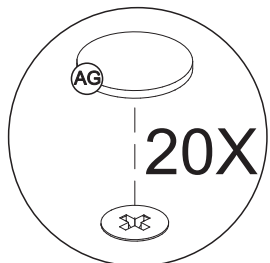

INSTRUÇÕES DE MONTAGEM INSTRUCCIONES DE ARMADO ASSEMBLY INSTRUCTIONS

REF.: 2338 / 2340

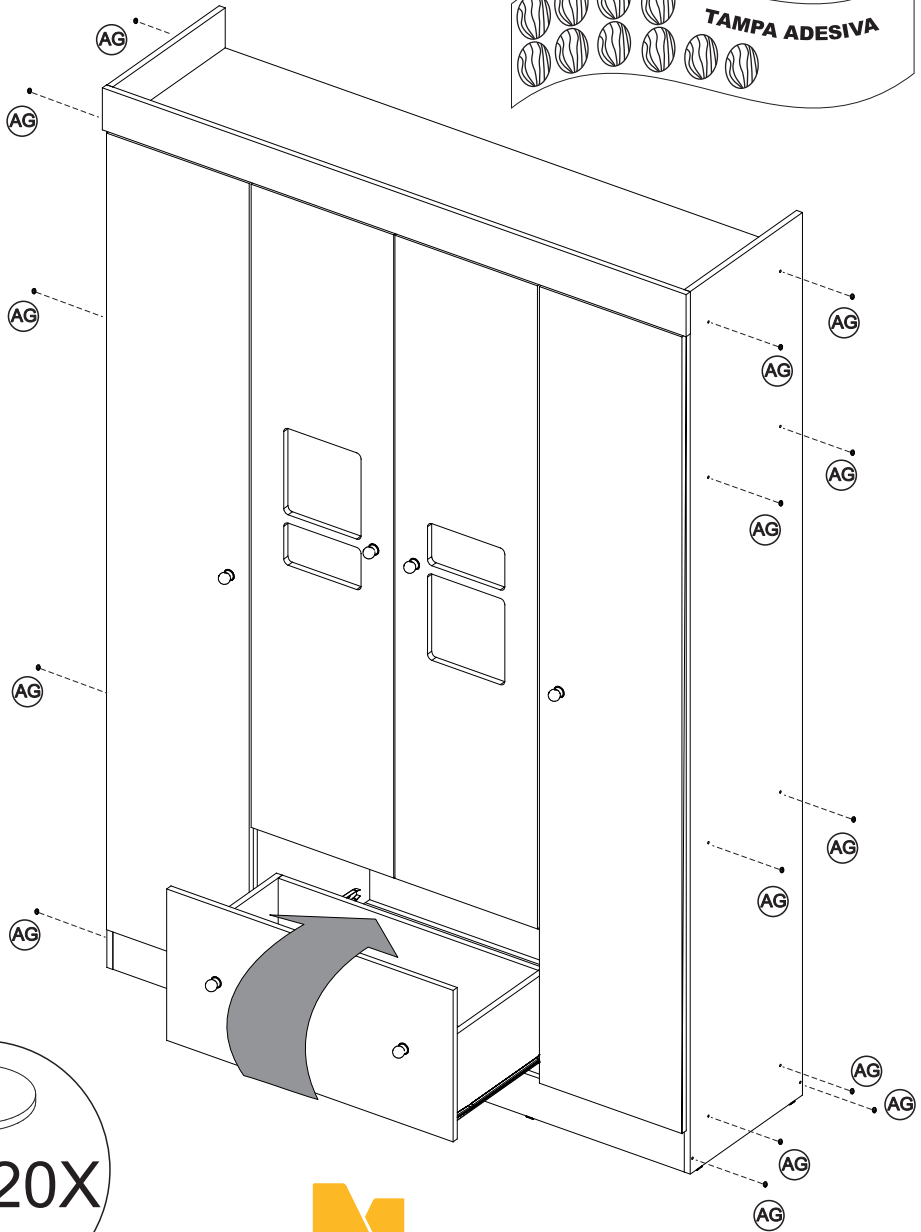
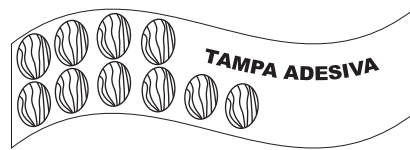
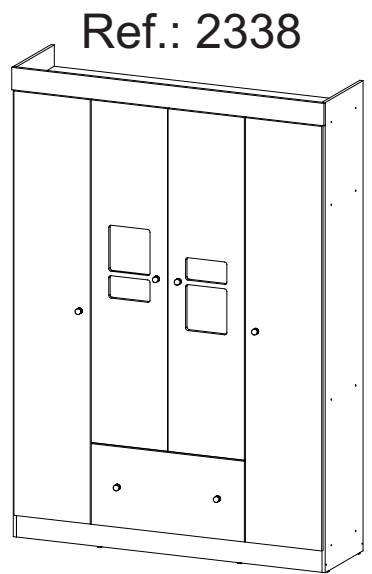
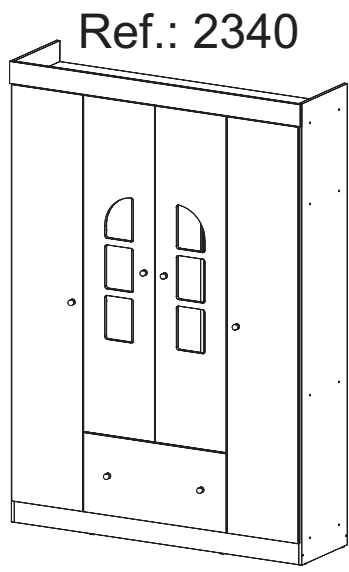

MULTIMÓVEIS
export



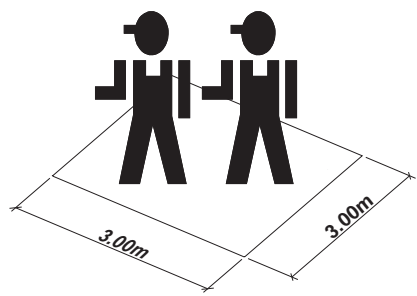







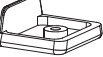

Rua Carlos Dreher Neto, 1918, Fone: (54) 2102 4000, FAX: (54) 2102 4050
CEP 95700-000 - BENTO GONÇALVES - RS - BRASIL
CNPJ: 00.349.443/0001-92
e-mail: multimoveis@multimoveis.com / site: www.multimoveis.com

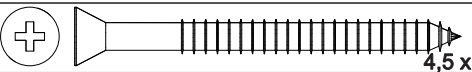
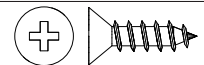

FERRAMENTAS NECESSÁRIAS
HERRAMIENTAS NECESARIAS
TOOLS NECESSARY

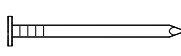
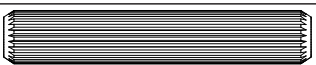
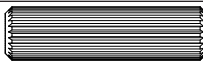

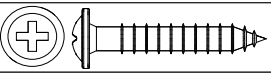
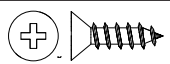
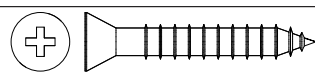
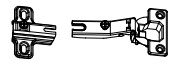
Ref.: 2338/2340- 14/Outubro/2015 - Rev. 01

AG		Tampa adesiva	34
FI			12
S			08
SU			08
U			02
BX		COLA	01
F			24
B		4,5 x 50	34
E		3,5 x 14	68
G		3,5 X 14	02
Y		10 x 10	100
J		8,0 X 50	04
H		8,0 X 30	38
N		6,0 X 30	04
AT		18 X 18	08
D		4,0 X 30	06
CC		3,5 X 12	28
V		4,0 x 35	08
AA			14
XX			06
CA			02

Passo
Paso
Step **10**

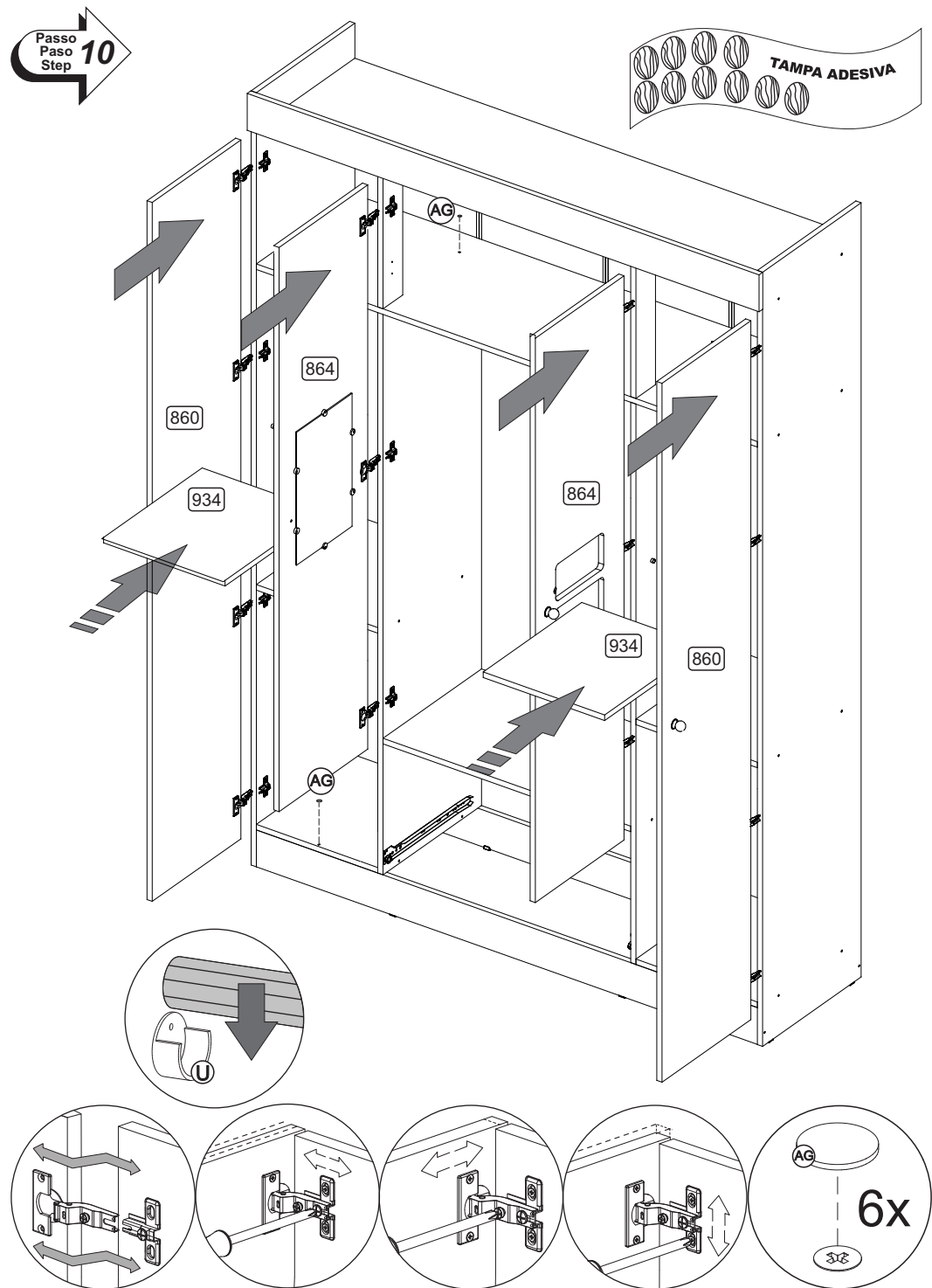

Passo
Paso
Step **08**

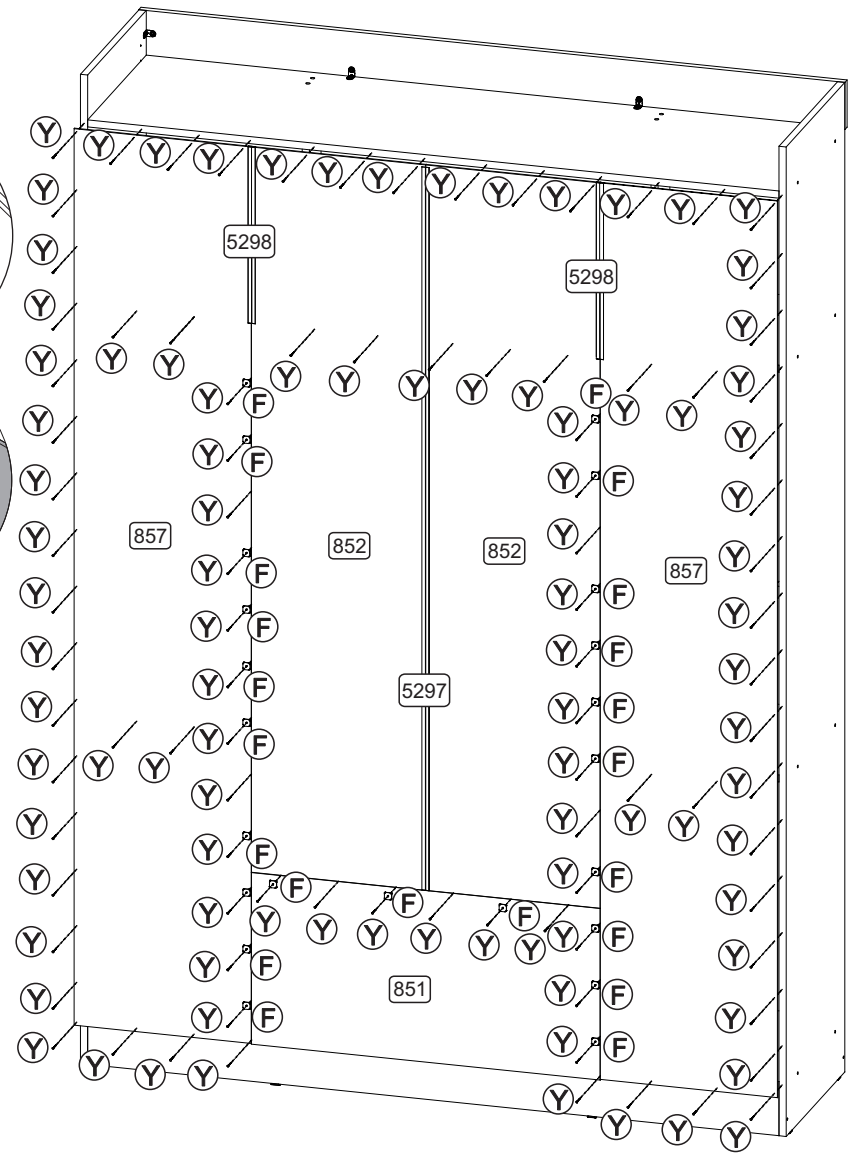
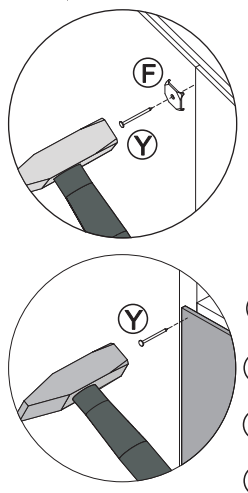

Passo
Paso
Step **09**

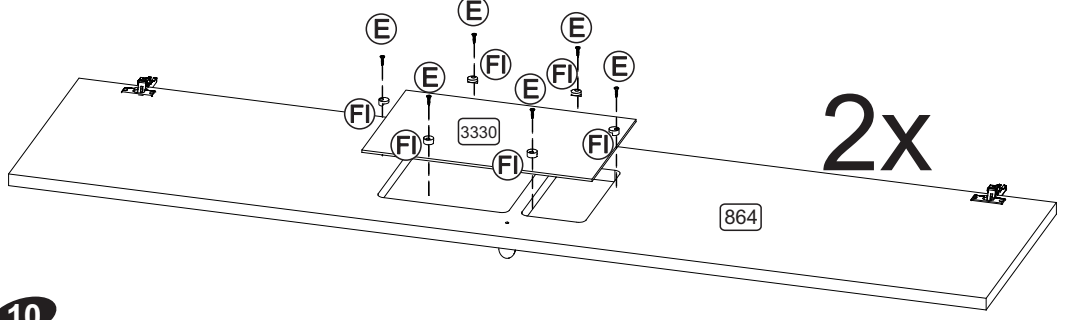

Senhor montador!
Informamos que a numeração das peças encontra-se no topo das mesmas conforme desenho acima.

Señor Armador!
Le informamos que la numeración de las piezas encuentranse arriba de las mismas, de acuerdo al modelo arriba.

Dear Assembler!
We inform you that the number of each piece is located on the top of it, according to the model shown above.

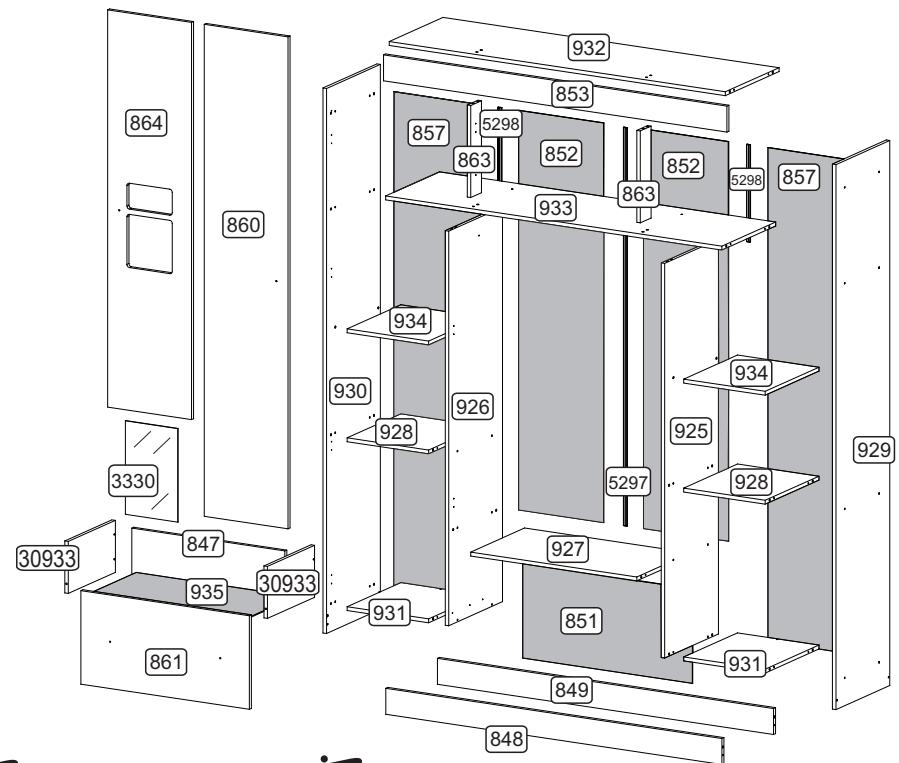

POR LISTA DE PEÇAS		ESP LISTA DE PIEZAS		ENG PART LIST	
Nº	DENOMINAÇÃO	Nº	DENOMINACIÓN	Nº	DESCRIPTION
30933	- LATERAL GAVETA MAIOR	30933	- LA LATERAL CAJÓN MAYOR	30933	- LARGER DRAWER SIDE
847	- COSTA DE GAVETA	847	- RESPALDO CAJÓN	847	- DRAWER BACK
848	- RODAPÉ FRONTAL	848	- ZÓCALO FRONTAL	848	- FRONT SKIRTING BOARD
849	- RODAPÉ TRASEIRO	849	- ESTANTE MENOR SUPERIOR	849	- LOWER UPPER SHELF
851	- COSTA	851	- RESPALDO	851	- BACK
852	- COSTA MENOR	852	- RESPALDO MENOR	852	- SMALLER BACK
853	- MOLDURA SUPERIOR	853	- MOLDURA SUPERIOR	853	- UPPER FRAME
925	- DIVISÃO DIREITA	925	- DIVISION DERECHA	925	- RIGHT DIVISION
926	- DIVISÃO ESQUERDA	926	- DIVISION IZQUIERDA	926	- LEFT DIVISION
927	- TAMPO GAVETA	927	- TAPA CAJÓN	927	- DRAWER TOP
928	- PRA TELEIRA	928	- ESTANTE	928	- SHELF
935	- FUNDO DE GAVETA	935	- FONDO CAJÓN	935	- BOTTOM DRAWER
857	- COSTA MAIOR	857	- RESPALDO MAYOR	857	- LARGER BACK
929	- LATERAL DIREITA	929	- LA LATERAL DERECHA	929	- RIGHT SIDE
930	- LATERAL ESQUERDA	930	- LA LATERAL IZQUIERDA	930	- LEFT SIDE
931	- BASE	931	- REGLA	931	- RULER
932	- TAMPO SUPERIOR	932	- TAPA SUPERIOR	932	- UPPER TOP
933	- TAMPO INTERMEDIÁRIO	933	- TAPA INTERMEDIARIA	933	- INTERMEDIATE TOP
860	- PORTA MAIOR	860	- PUERTA MAYOR	860	- LARGER DOOR
861	- FRENTE DE GAVETA	861	- FRENTE CAJÓN	861	- FRONT DRAWER
863	- PILASTRA	863	- PILASTRA	863	- DOOR STOP
864	- PORTA VAZADA	864	- PUERTA CON AGUJERO	864	- FRAME DOOR
934	- PRA TELEIRA MOVEL	934	- ESTANTE MOVIL	934	- MOVABLE SHELF
3330	- VIDRO	3330	- VIDRIO	3330	- GLASS
5297	- PERFIL I MAIOR	5297	- PERFIL I MAYOR	5297	- LARGER I PROFILE
5298	- PERFIL I MENOR	5298	- PERFIL I MENOR	5298	- SMALLER I PROFILE

