















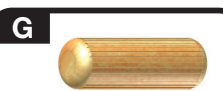
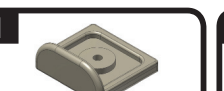
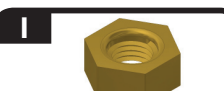



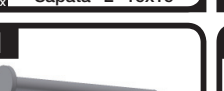



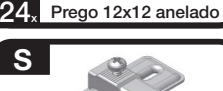

LISTA DE PEÇAS

Item	Caixa	Qty	Descrição	Medidas (mm)
01	1/6	01	Rodapé frontal maior/ Pie frontal más	1623x73x15
02	3/6	01	Travessa do rodapé/ Carril pie	472x73x15
03	1/6	01	Rodapé traseiro maior/ Pie trasero más	1623x73x15
04	3/6	01	Divisão esquerda/ División izquierda	2250x600x15
05	4/6	01	Base/ Base	1623x540x15
06	3/6	01	Divisão direita/ División derecha	2250x600x15
07	3/6	01	Divisão/ División	2162x540x15
08	4/6	02	Prateleira do calceiro/ Estante del calceiro	804x250x15
09	2/6	06	Prateleira/ Estante	804x450x15
10=15	4/6	01	Rodapé frontal/ Pie frontal	392x73x15
11=16	1/6	01	Rodapé traseiro/ Pie trasero	392x73x15
12	1/6	01	Lateral esquerda/ Lateral izquierda	2250x600x15
13=18	4/6	01	Tampa da cômoda/ Cubierta dresser	392x600x15
14=19	2/6	01	Prateleira menor/ Estante menos	392x450x15
15=10	4/6	01	Rodapé frontal/ Pie frontal	392x73x15
16=11	1/6	01	Rodapé traseiro/ Pie trasero	392x73x15
17	1/6	01	Lateral direita/ Lateral derecha	2250x600x15
18=13	4/6	01	Tampa da cômoda/ Cubierta dresser	392x600x15
19=14	2/6	01	Prateleira menor/ Estante menos	392x450x15
20	4/6	01	Tampo/ Cubierta	2467x645x15
21	3/6	02	Moldura lateral/ Marco lateral	645x50x15
22	4/6	01	Moldura frontal/ Marco frontal	2497x50x15
23	1/6	06	Fundo/ Fondo	2200x407x3
24	6/6	04	Porta central/ Puerta central	2162x402x15
25	5/6	01	Porta espelho esquerda/ Puerta espejo izquierda	1615x402x15
26	5/6	01	Porta espelho direita/ Puerta espejo derecha	1615x402x15
27	2/6	06	Frente de gaveta/ Frente de cajón	402x178x15
28	2/6	12	Lado de gaveta/ Lado del cajón	400x122x15
29	2/6	06	Fundo de gaveta/ Fondo del cajón	348x411x3
30	4/6	06	Ripa de trás/ Malla detrás	367x122x15
31	4/6	04	Divisória maior/ Tabique más	400x60x9
32	4/6	04	Divisória menor/ Tabique menos	337x60x9
33	5/6	02	Espelho 524x392x3mm com furo/ Espejo 524x392x3mm con orificio	524x392x3
34	5/6	02	Espelho 1065x392x3mm com furo/ Espejo 1065x392x3mm con orificio	1065x392x3

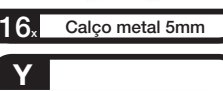
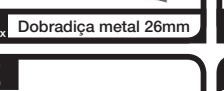
LISTA DE FERRAGENS

A  12, Paraf. 4,5x50mm CHT.	B  08, Paraf. 4,0x25mm FLA.	C  42, Paraf. 3,5x40mm CHT.	D  16, Paraf. 3,5x25mm FLA.	E  98, Paraf. 3,5x14mm FLA.	F  112, Paraf. 3,5x12mm CHT.
G  128, Cavilha 8x25mm	H  12, Sapata "L" 15x15	I  08, Porca sextavada	J  12, Porca cilíndrica	K  02, Batente 15x25mm	L  14, Cantoneira plástica
M  24, Prego 12x12 anelado	N  215, Prego 10x10	O  54, Fixador de fundos	P  05, Conector de montagem	Q  08, Puxador kannan	R  08, Calço metal 12mm
S  16, Calço metal 5mm	T  24, Dobradiça metal 26mm	U  06, Corrediça telescópica	V  08, Suporte cabideiro	W  04, Puxador Aurora 672mm	X  02, Perfil "H" 2172mm
Y  02, Cabideiro alum. 798mm	Z  02, Cabideiro alum. 386mm	AA  02, Sachê de cola	AB  01, Giz de correção	AC  43, Adesivo tapa parafuso 10mm	AD  01, Etiqueta resinada Henn

HENN

MÓVEIS
DO SEU
JEITO

www.henn.com.br
henn@henn.com.br
55 49 3674 3500
Mondai/SC - Brasil

INSTRUÇÃO DE MONTAGEM INSTRUCCIONES DE MONTAJE

Roupeiro Valentino 06 Portas/ Armario Valentino 06 Puertas

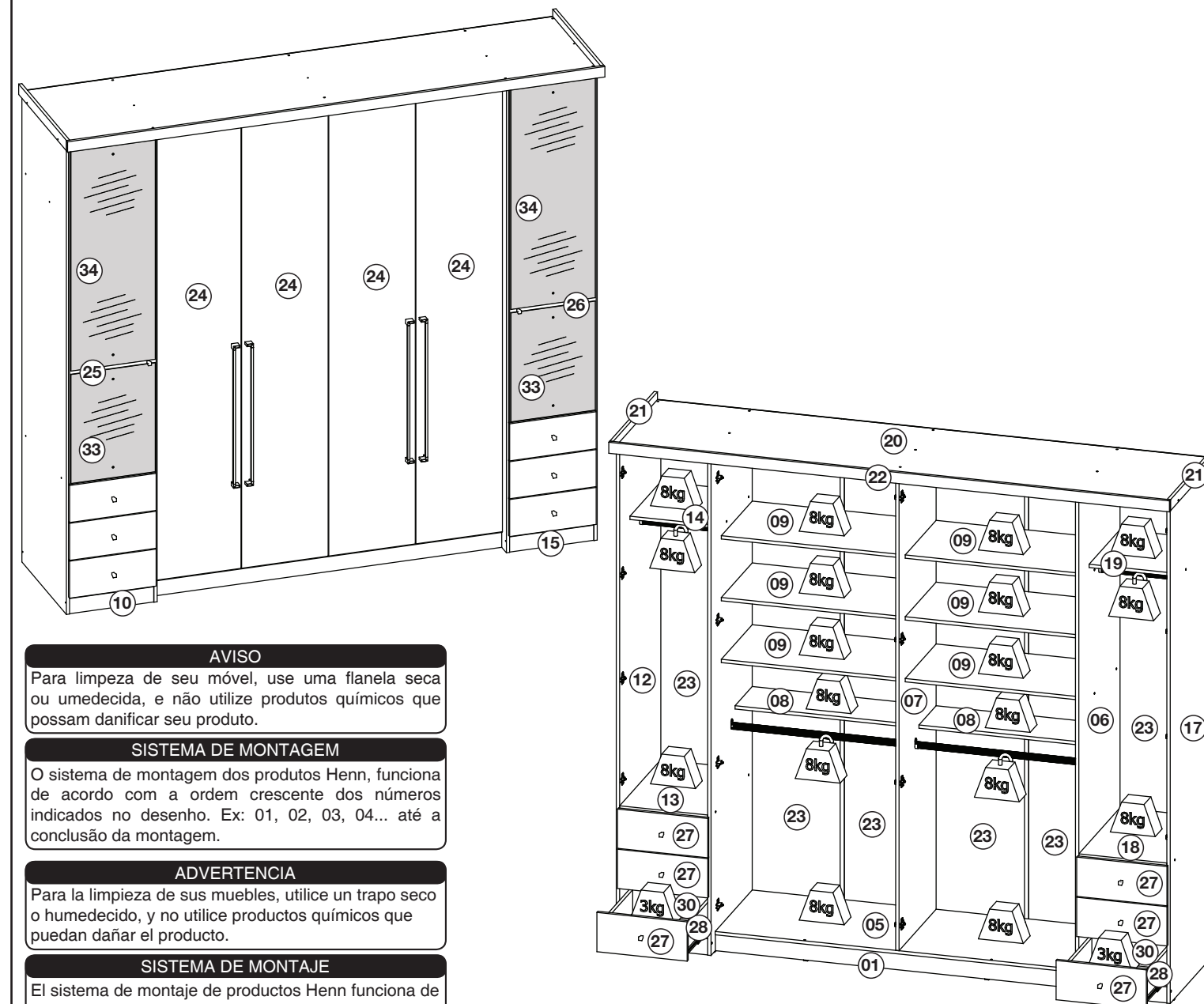

AVISO

Para limpeza de seu móvel, use uma flanela seca ou umedecida, e não utilize produtos químicos que possam danificar seu produto.

SISTEMA DE MONTAGEM

O sistema de montagem dos produtos Henn, funciona de acordo com a ordem crescente dos números indicados no desenho. Ex: 01, 02, 03, 04... até a conclusão da montagem.

ADVERTENCIA

Para la limpieza de sus muebles, utilice un trapo seco o humedecido, y no utilice productos químicos que puedan dañar el producto.

SISTEMA DE MONTAJE

El sistema de montaje de productos Henn funciona de acuerdo con el orden de los números indicados en el dibujo. Ejemplo: 01, 02, 03, 04 ... hasta la realización de la asamblea.

- D163-10 - Branco
- D163-12 - Malbec
- D163-70 - Amêndoa

REQUISITOS PARA MONTAGEM REQUISITOS PARA LA ASAMBLEA

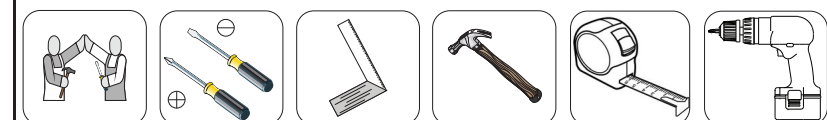

Imagens meramente ilustrativas / Imágenes meramente ilustrativas

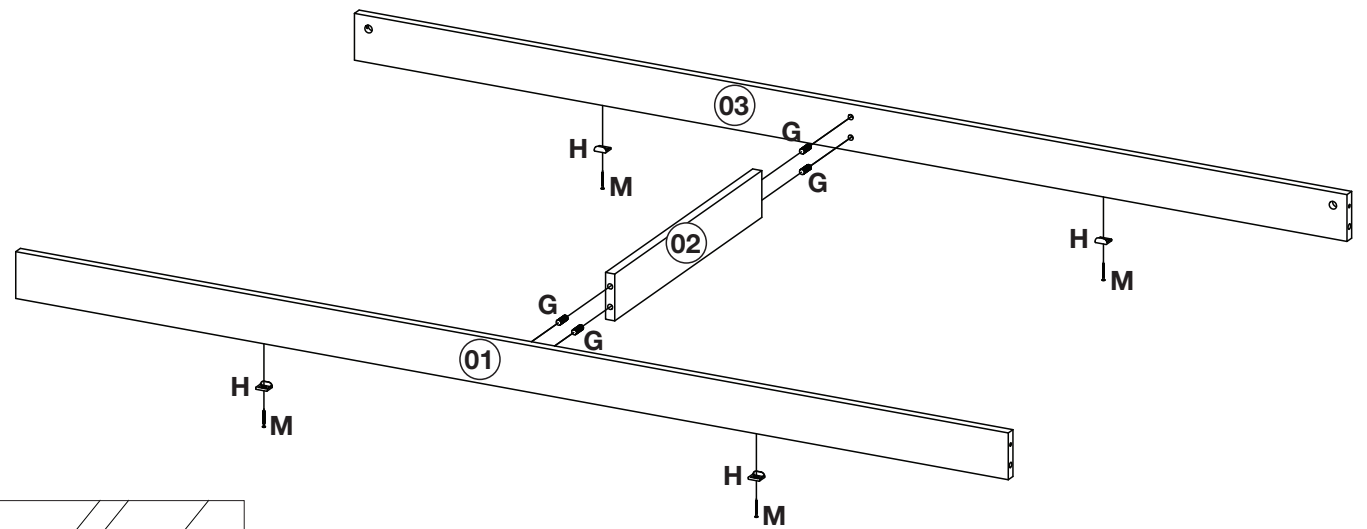

Fixação da cantoneira (L) nos rodapés (01) e (03) com a travessa (02).

Soporte de fijación (L) los zócalos (01) y (03) con el travesaño (02).

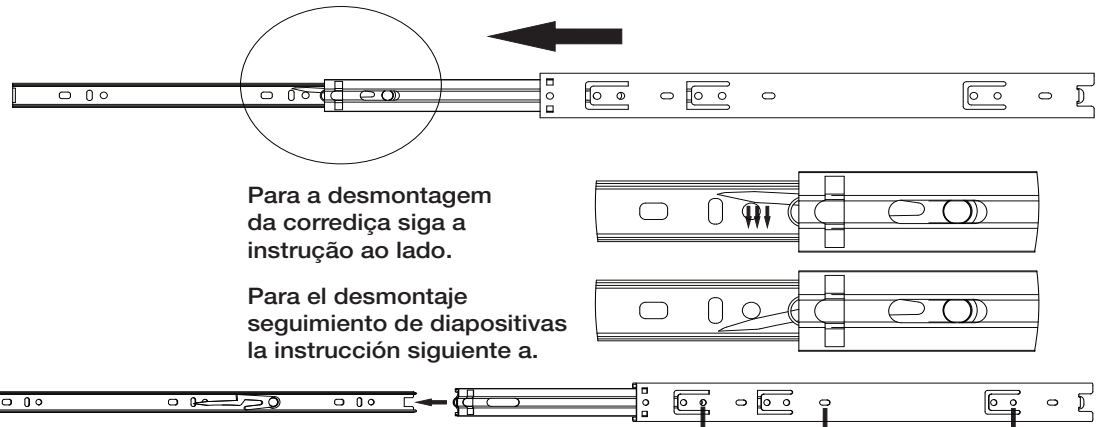
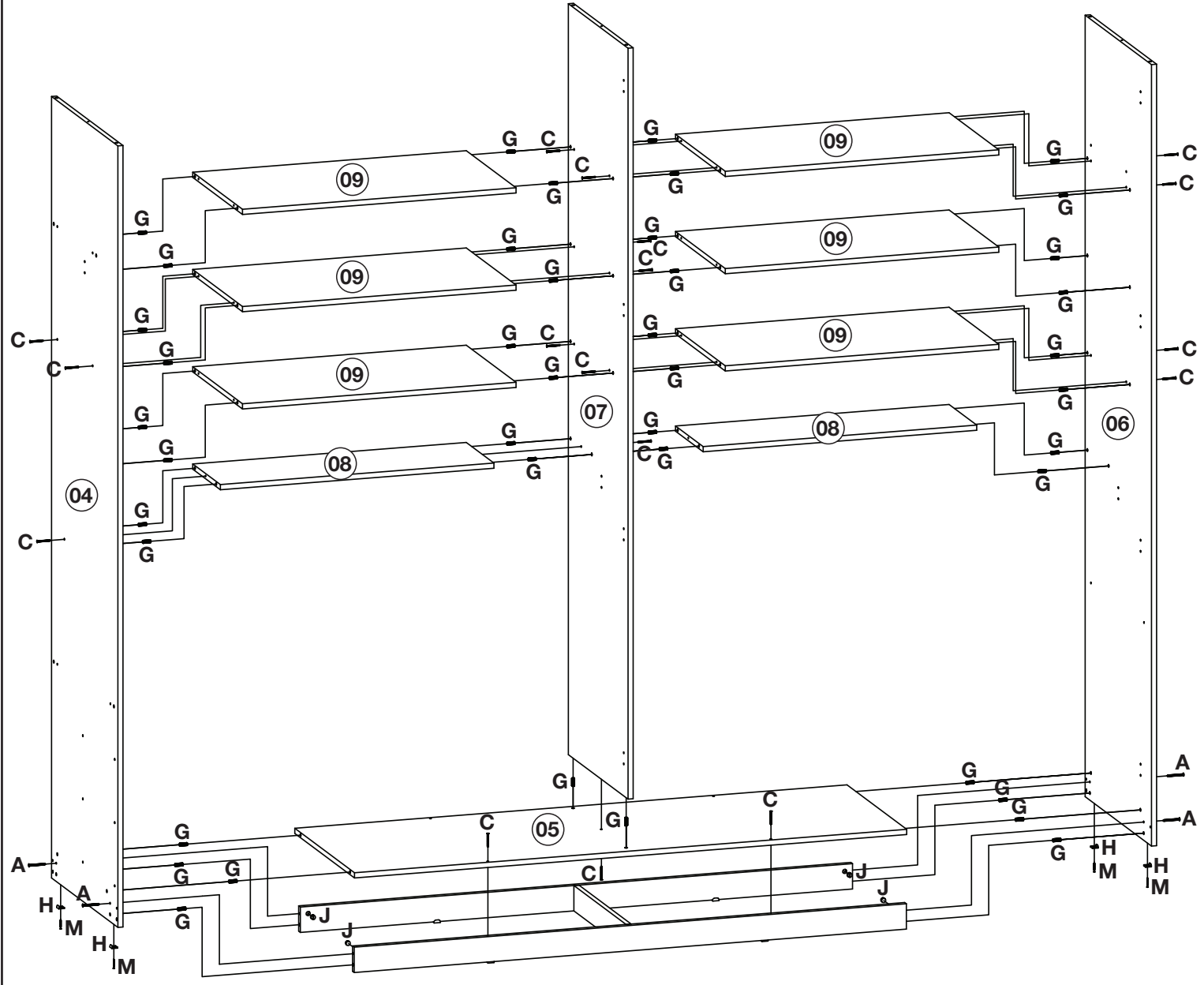
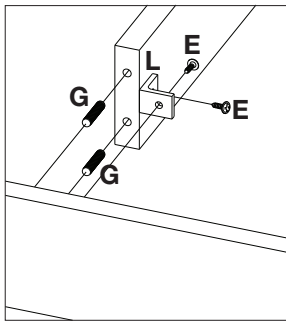

Para a desmontagem da corrediça siga a instrução ao lado.

Para el desmontaje seguimiento de diapositivas la instrucción siguiente a.

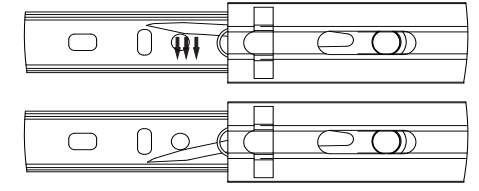

Fixar as corrediças nessas furações
Fijar las diapositivas de estos agujeros

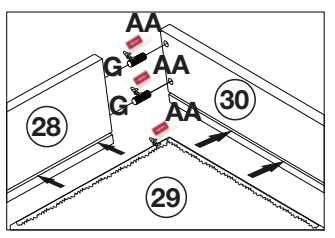
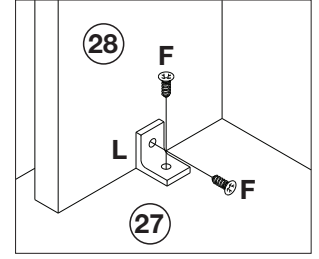
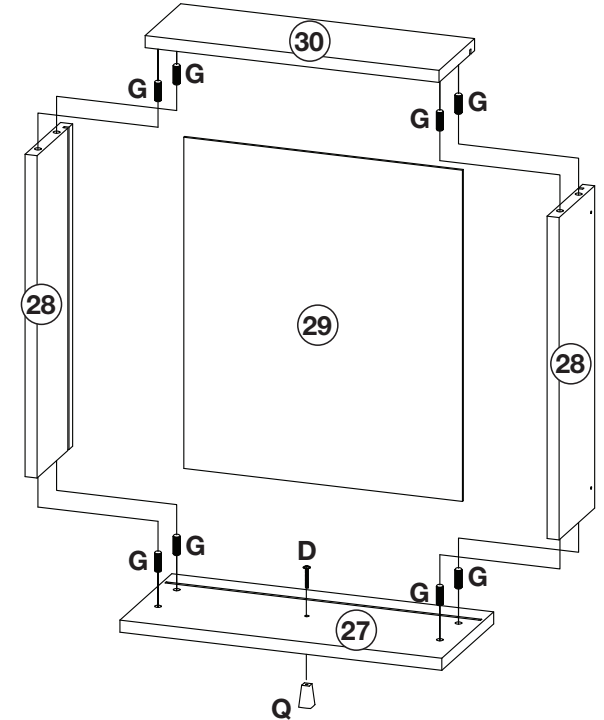

Utilize o sachê de cola (AA) nas cavilhas (G) e nos frisos da gaveta

Utilice bolsita de pegamento (AA) los pasadores (G) y en los frisos del cajón

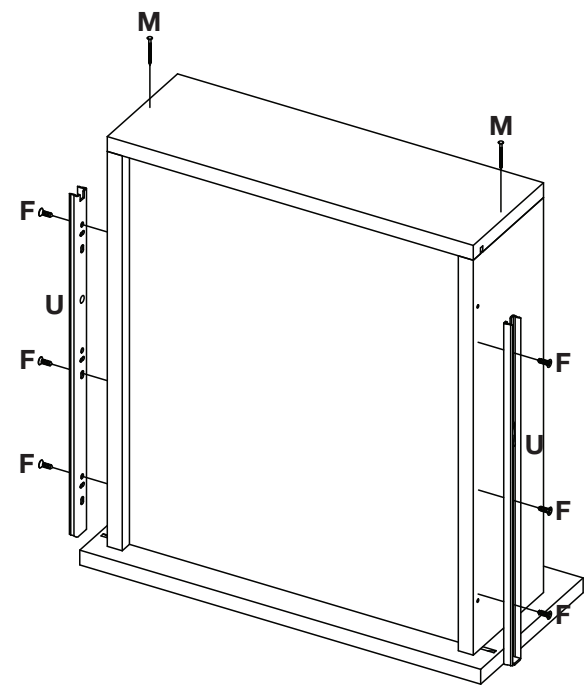

Duas gavetas serão com divisórias maior (31) e menor (32).

Dos cajones están con los divisores más (31) e menos (32).

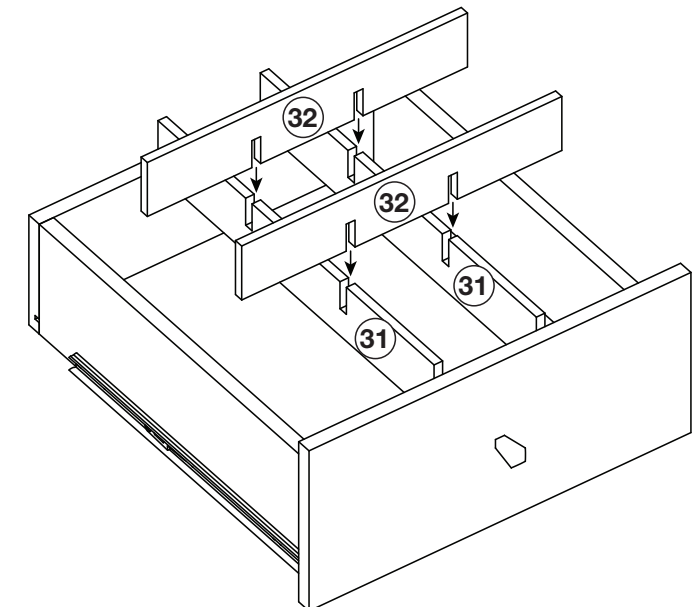

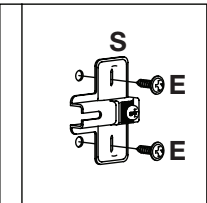
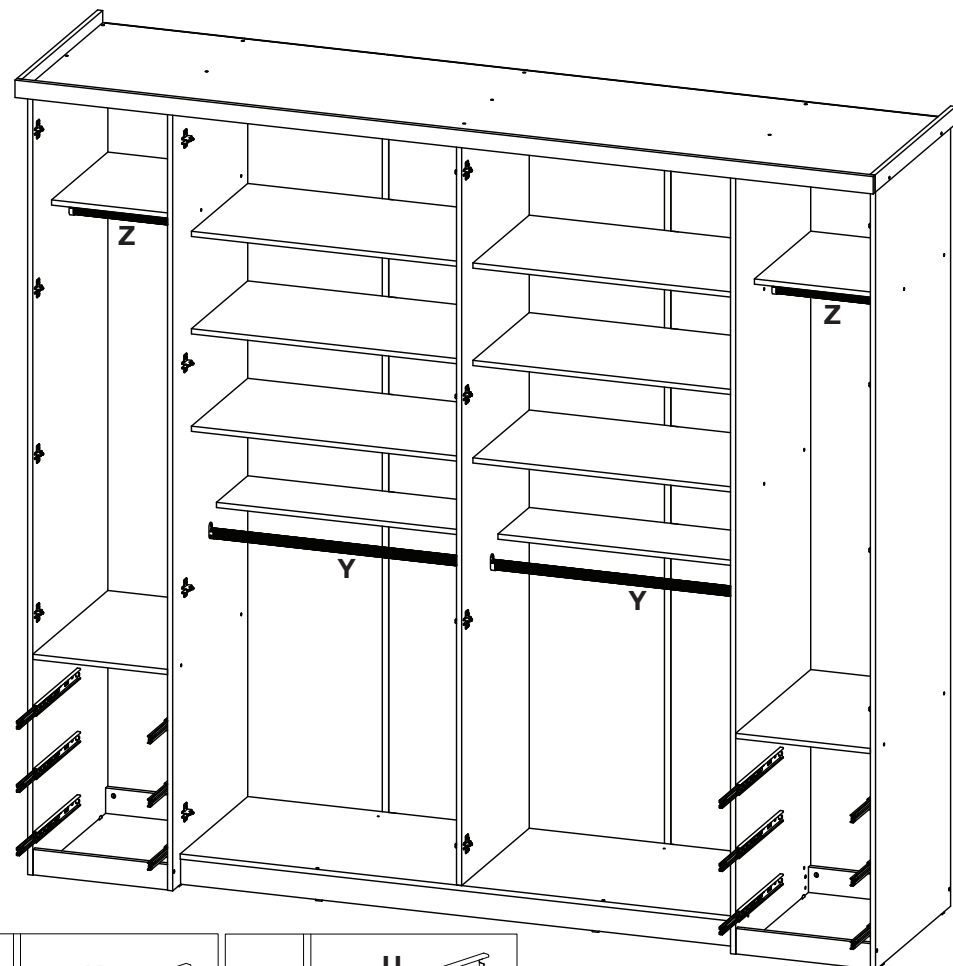

Fixação dos calços (S) nas laterais (12) e (17).
 La fijación de las cuñas (S) el lado (12) y (17).

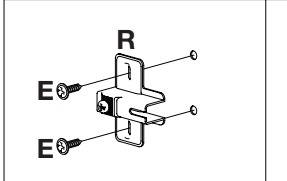

Fixação dos calços (R) nas divisões (04) e (06).
 La fijación de las cuñas (R) el divisiones (04) y (06).

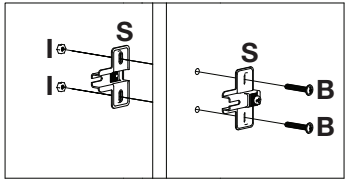

Fixação dos calços (S) na divisão (07).
 La fijación de las cuñas (S) el division (07).

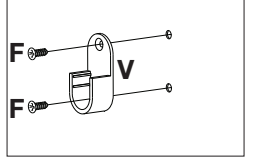
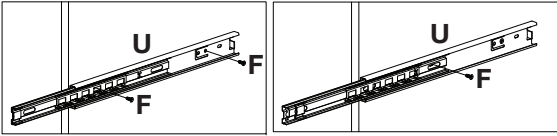

Fixação da corredeira (U).
 Configuración de diapositivas (U).

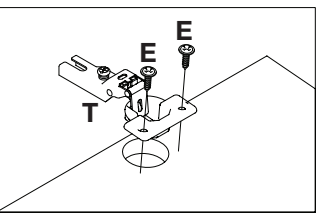
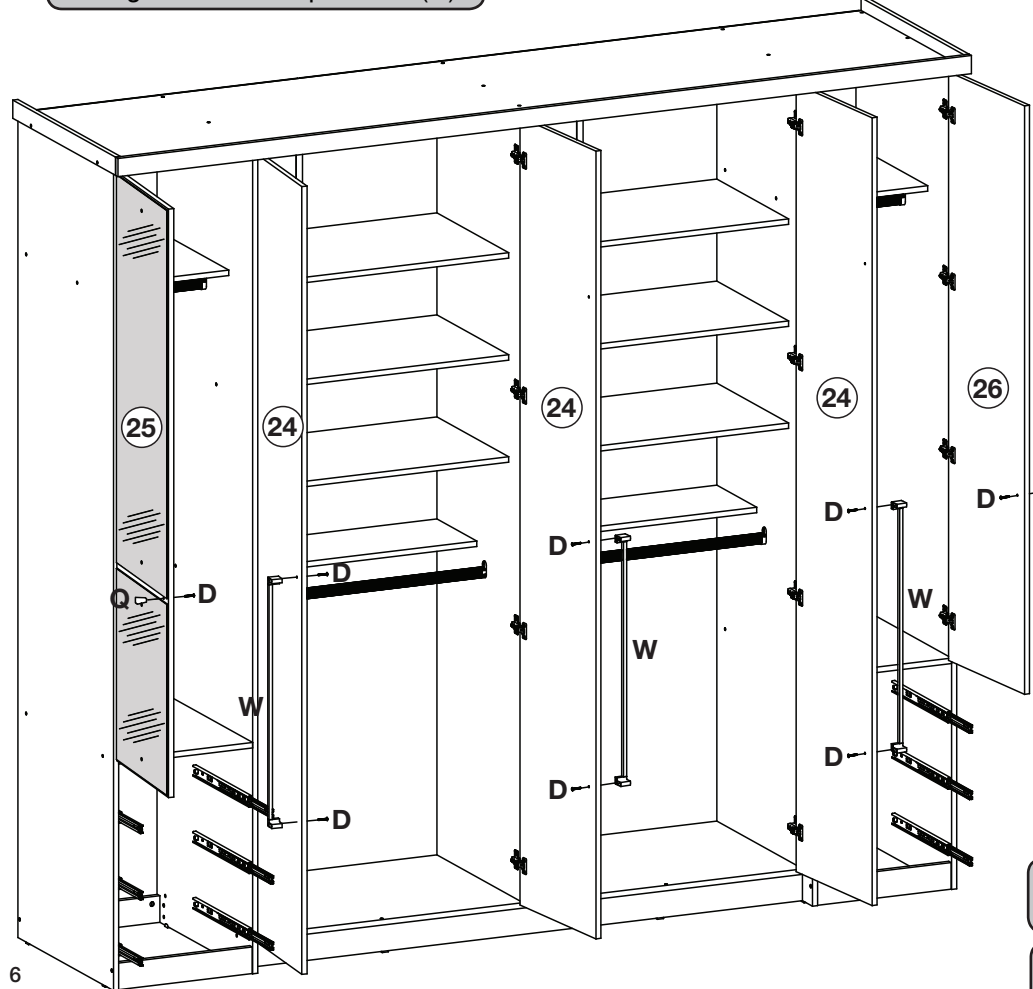

Colocação das dobradiças (T).
 La colocación de las bisagras (T).

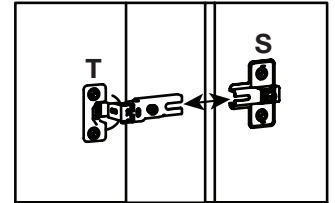

Encaixe dos calços (R) e (S) com as dobradiças (T).
 Cuñas de ajuste (R) y (S) con las bisagras (T).

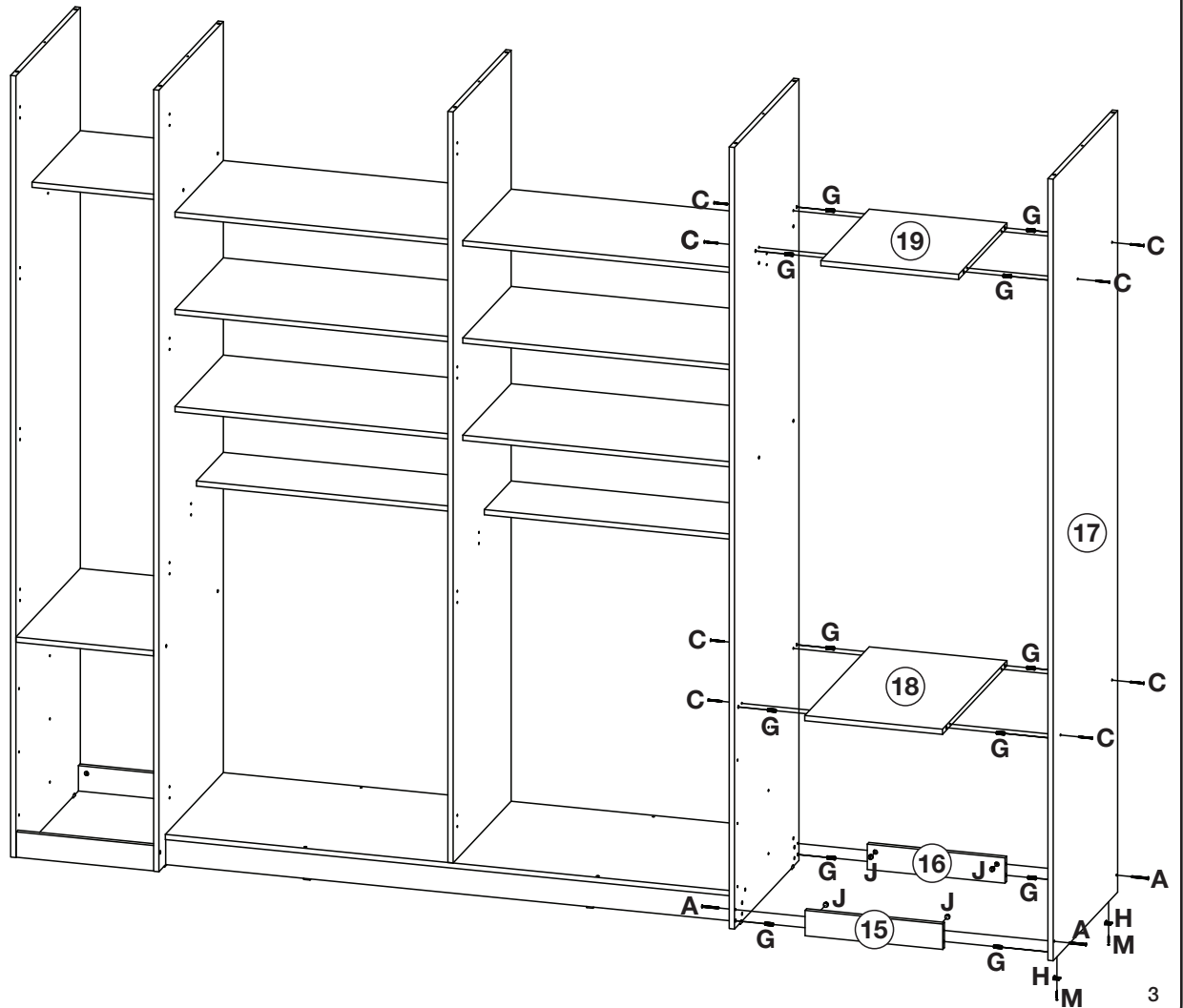
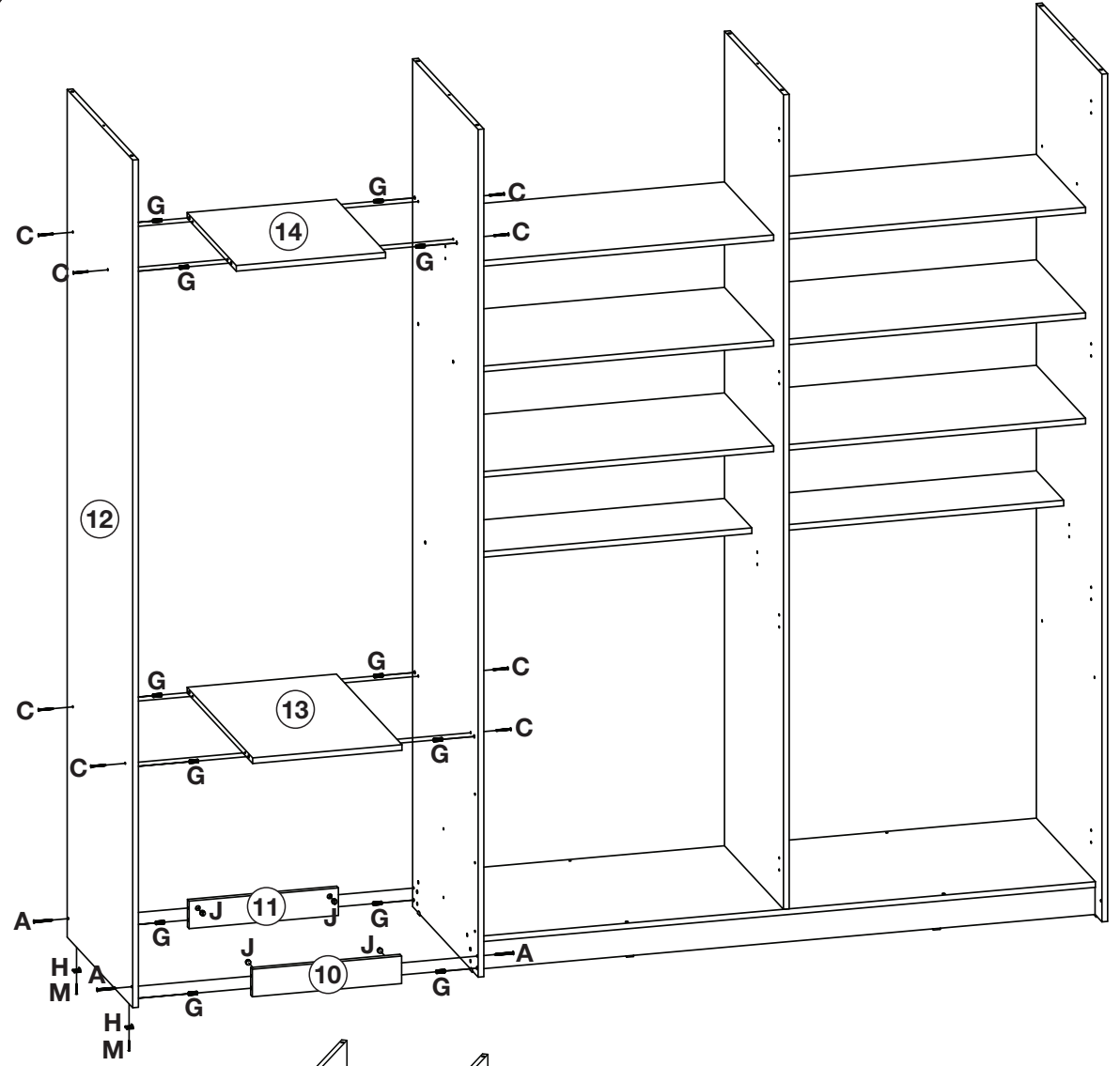

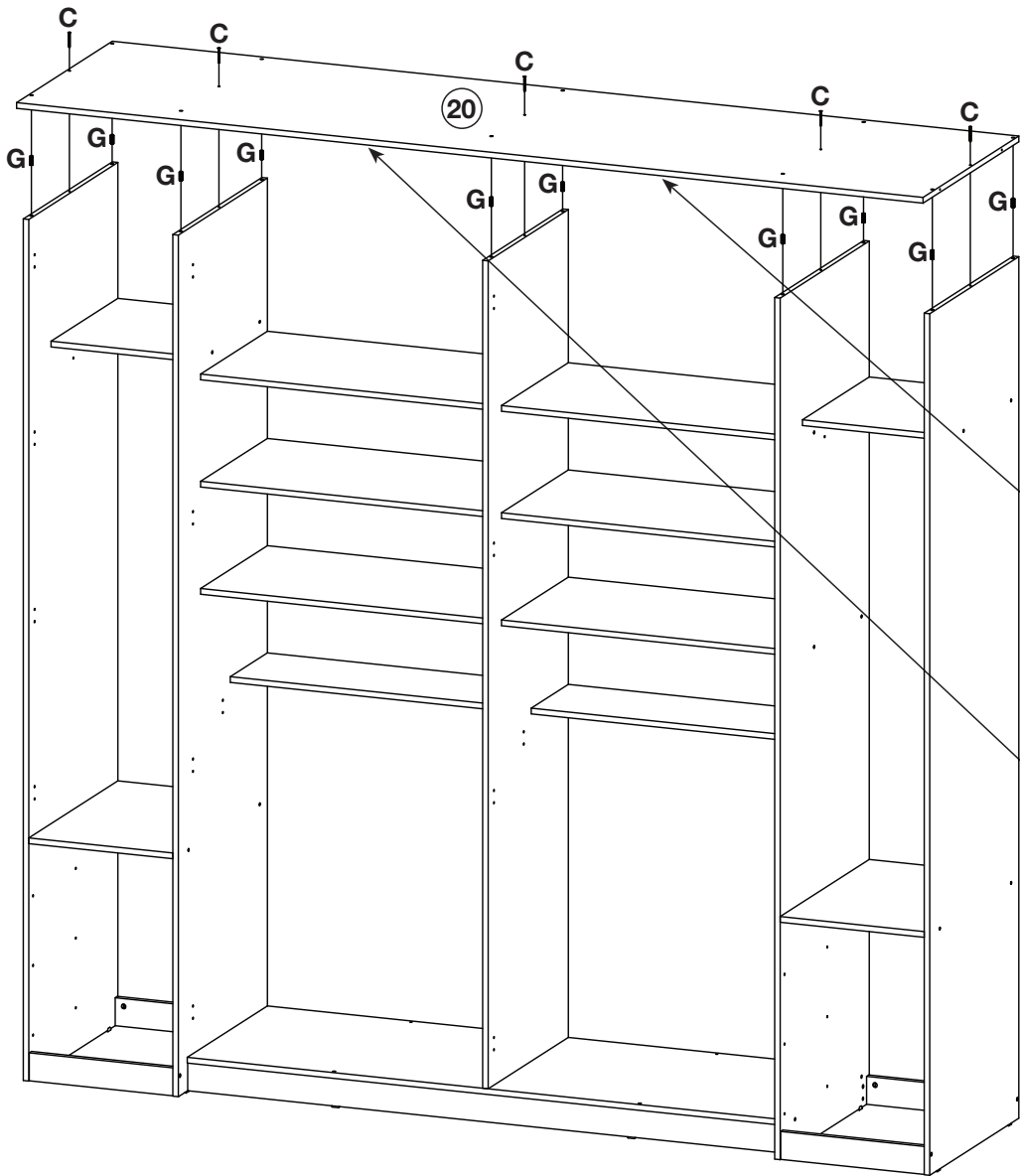

Importante:
Colocação do batente 15x25mm (K) que serve como batente da porta.

Importante:
Colocación de detener 15x25mm (K) que sirve como detener de la puerta.

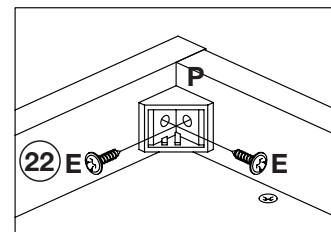
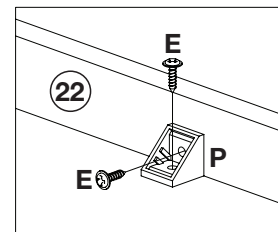
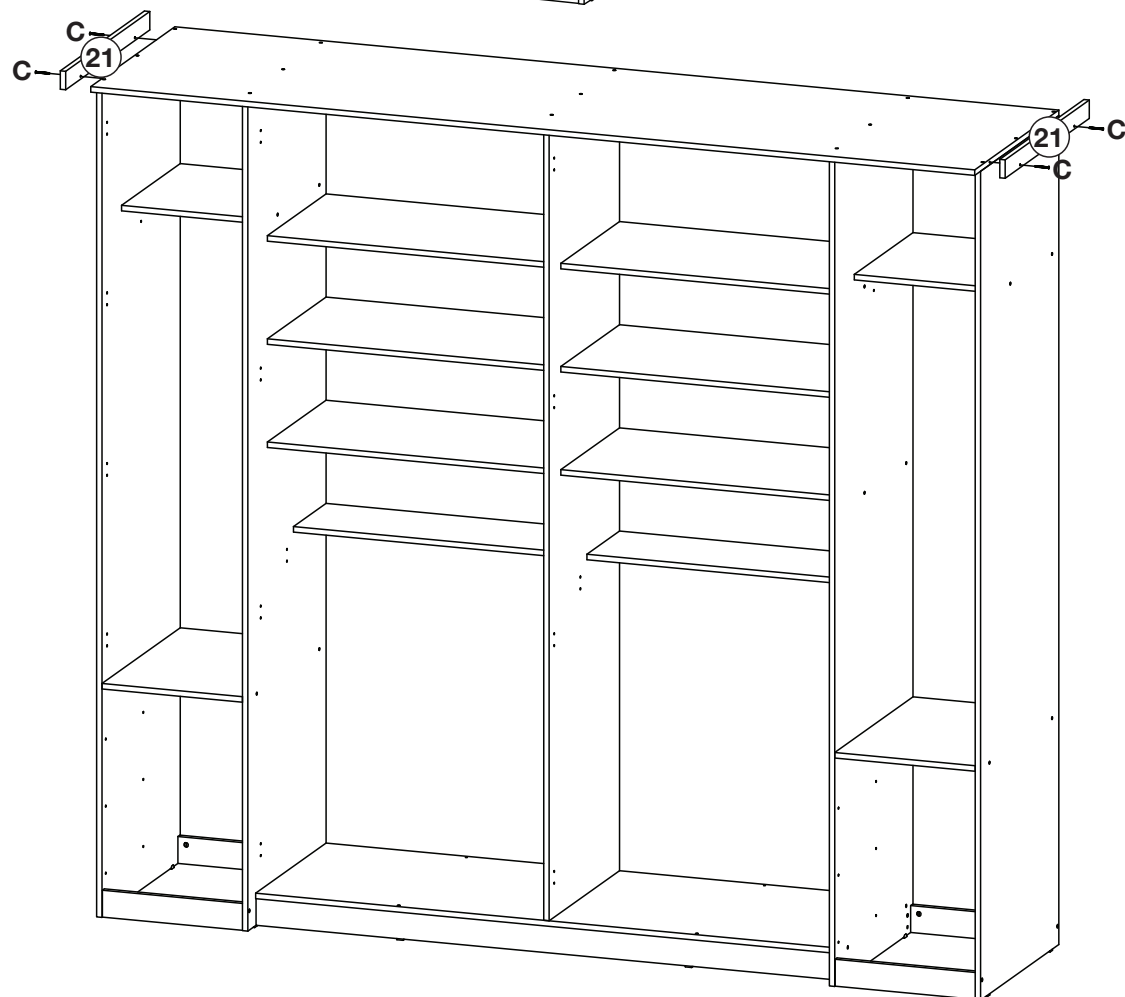
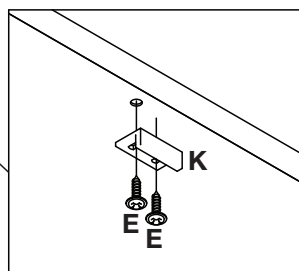
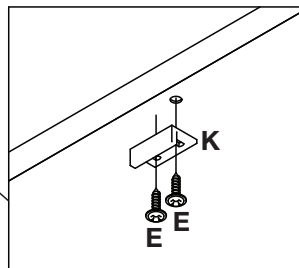

Colocação dos conector de montagem (P) na moldura frontal (22).

La colocación del conector de montaje (P) el marco frontal (22).

