

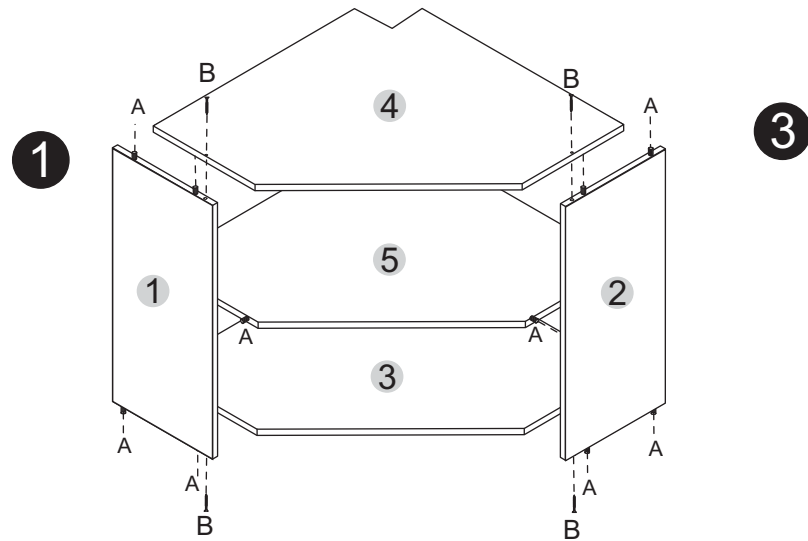

Ferragens/Herrajes (Cód. 23440)

A		12
B		10
C		22
D		01
E		04
F		02
G		04
H		04
I		50
J		02
K		02
L		02



3

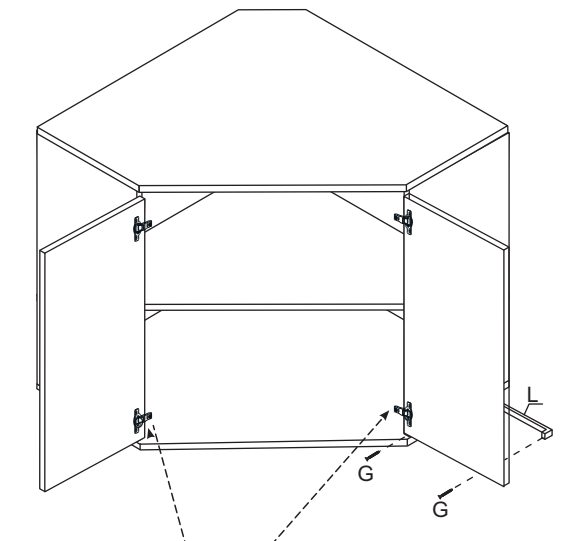

2

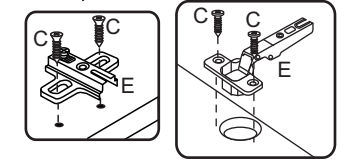
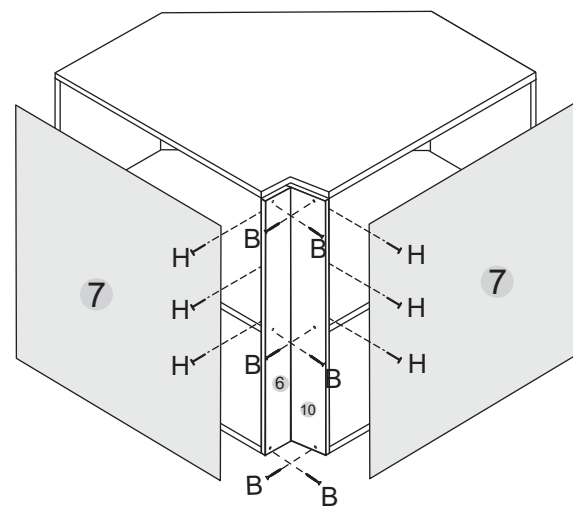

Accessórios separados/Accesorios

N		02
---	--	----

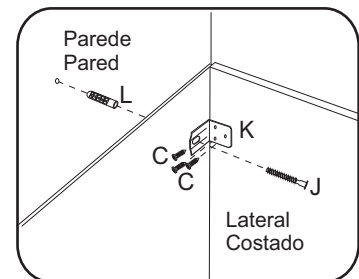
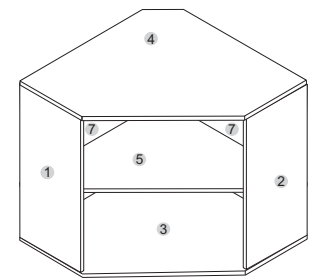
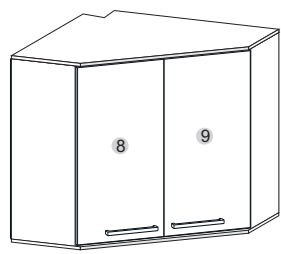

Nº. da peça	Código da peça*			Descrição da peça	Dimensões	Qtd.
	NOVER	CARVALHO	CHAMPANHE			
1	23041	-----	-----	Lateral esquerda/ Lateral izquierda	510 x 283 x 15	1
2	23040	-----	-----	Lateral direita/ Lateral derecha	510 x 283 x 15	1
3	23424	-----	-----	Base/ Base	750 x 750 x 15	1
4	23423	-----	-----	Tampo/ Tapa	750 x 750 x 15	1
5	23427	-----	-----	Prateleira/ Estante	735 x 735 x 15	1
6	23425	-----	-----	Pilastra/ Pilastra	510 x 100 x 15	1
7	23422	-----	-----	Costal/ Dorso	660 x 530 x 3	2
8	-----	-----	23431	Porta esquerda/ Puerta izquierda	505 x 338 x 15	1
9	-----	-----	23428	Porta direita/ Puerta derecha	505 x 338 x 15	1
10	23426	-----	-----	Pilastra/ Pilastra	510 x 85 x 15	1