

7270 Rustic

MADESA
MÓVEIS

MD Móveis Ltda.
Bom Princípio/RS - Brasil
Fone: 51 3534 8000 Fax 51 3534 8008
E-mail: in@madesa.com.br

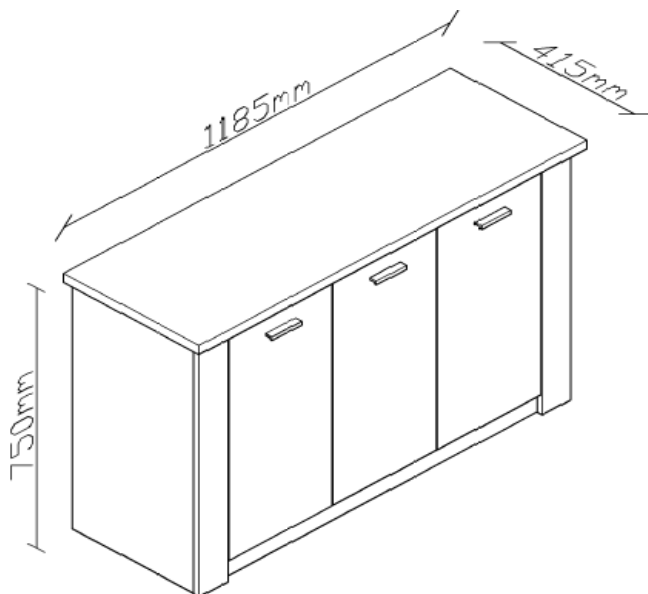

N°	Qtd.	Descrição	Matéria - Prima	Dimensões	Rustic
1	1	Base	MDP	15x373x1100	203472705Z01
2	1	Tampo	MDP	25x415x1185	203472705Z02
3	1	Lateral Direita	MDP	15x375x725	203472475Z03
4	1	Lateral Esquerda	MDP	15x375x725	203472475Z04
5	1	Divisória	MDP	15x85x650	203472705Z05
7	1	Porta Maior Dir.	MDP	15x317x660	203472705Z07
8	1	Porta Maior Esq.	MDP	15x317x660	203472705Z08
9	1	Porta Maior Central	MDP	15x317x660	203472705Z09
10	1	Prateleira	MDP	15x285x1100	203472705Z10
11	2	Rodapé Inf.	MDP	15x60x1100	203472705Z11
12	1	Montante Lat. Dir.	MDP	15x85x725	203472475Z12
17	3	Costa	MDF	03x370x670	2033727013170
20	1	Montante Lat. Esq.	MDP	15x85x725	203472475Z20
2		União Costas		650mm	2070065014012

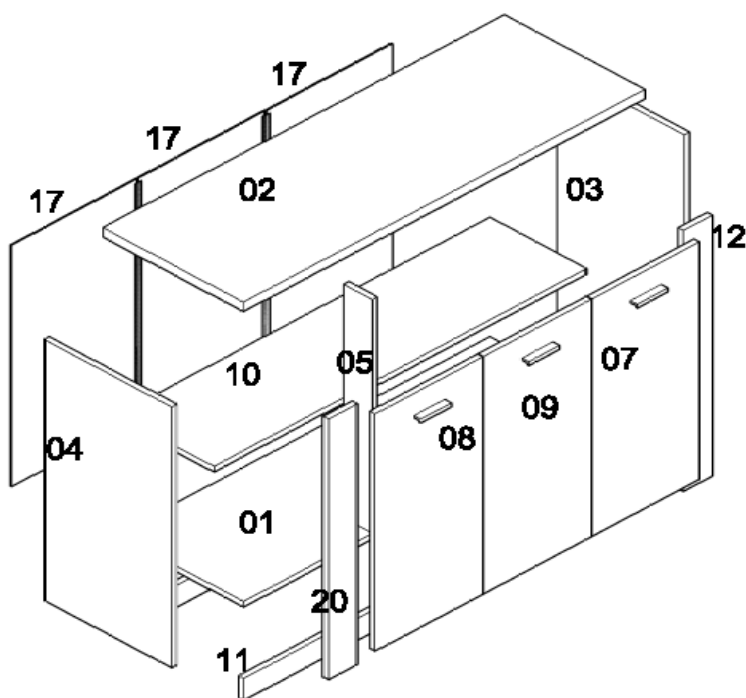

Parabéns pela aquisição de um produto de qualidade, presente em mais de 60 países, nos 5 continentes. Antes de iniciar a montagem confira todos os componentes com a lista de peças ao lado. Em caso de dúvidas procure a loja em que efetuou a compra. Observe atentamente as instruções e siga rigorosamente as etapas de montagem. Com o uso não esqueça de apertar os parafusos periodicamente.

ENGLISH: Congratulations for your purchase. This is a fine-quality product sold in over sixty countries. Please check all components before assembly. Follow the assembly instructions carefully. Be sure to regularly tighten the screws.

ESPAÑOL: Felicitaciones! Usted acaba de adquirir un producto de alta calidad, presente en más de sesenta países en los cinco continentes. Antes de empezar el armado, egúrese de que estén todos los componentes de la Lista. Si tiene dudas, dirijase a la tienda en que hizo la compra. Observe atentamente las instrucciones y siga rigurosamente las etapas del montaje. Ajuste los tornillos regularmente.

FRANÇAISE: Nos félicitations pour l'achat d'un produit haut de gamme, présent dans plus d'une soixante de pays dans les cinq continents. Avant de commencer le montage, vérifiez tous les composants à l'aide de la liste de pièces. En cas de doute, cherchez le magasin ou vous avez fait l'acquisition. Observez les instructions avec attention et suivez soigneusement chaque étape du montage. Avec l'usage, n'oubliez pas de resserrer les vis de temps en temps.













Os painéis traseiros (costas) fixam a estrutura. Assegure-se de que a estrutura tenha ângulos retos (90°), antes de pregar os painéis. Pelo contrário o móvel não ficará firme.

The BACK Panels are responsible for holding the frame. This is the reason the structure must be assembled at right angles (90°) BEFORE nailing the back panel in place.

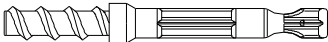
Los paneles traseros fijan la estructura. Asegúrate de que la estructura tenga ángulos rectos (90 grados) ANTES de colocar los clavos del panel. De lo contrario el mueble quedará inclinado.

C'est le dos qui maintient la structure. Il est donc important que la structure soit d'aplomb (angles à 90 degrés) avant de commencer à clouer le dos. Dans le cas contraire, le meuble ne sera pas stable.

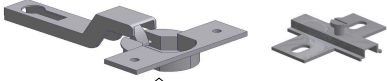
7270 Rustic

Ref.	Quant.	Descrição	Dim. (mm)	Imagem
P6	34	Parafuso CP FC	3,5x14	
P29	6	Parafuso CP FC	M4x18	
S4	8	Suporte Ang. com guia		
D1	8	Deslizador de cama		
S5	5	Suporte Ang. sem guia		
T9	4	Tapa Furo Tambor		
S12	4	Suporte Prateleira	8x6	
M2	8	Minifix Parafuso	6x35	
Q7	50	Prego	10x10	
T2	8	Tambor Para Minifix	15x12	
C9	16	Cavilha	6x30	
K3	1	Kit 4 Dobradiça 180/270		
D2	2	Dobradiça(Meia Sobrep.)	26mm	
XX	3	Puxador	64	

7270 Rustic

