

INSTRUÇÕES DE MONTAGEM  
INSTRUCCIONES DE ARMADO  
ASSEMBLY INSTRUCTIONS

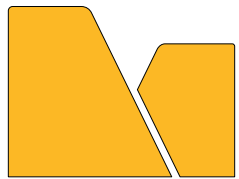

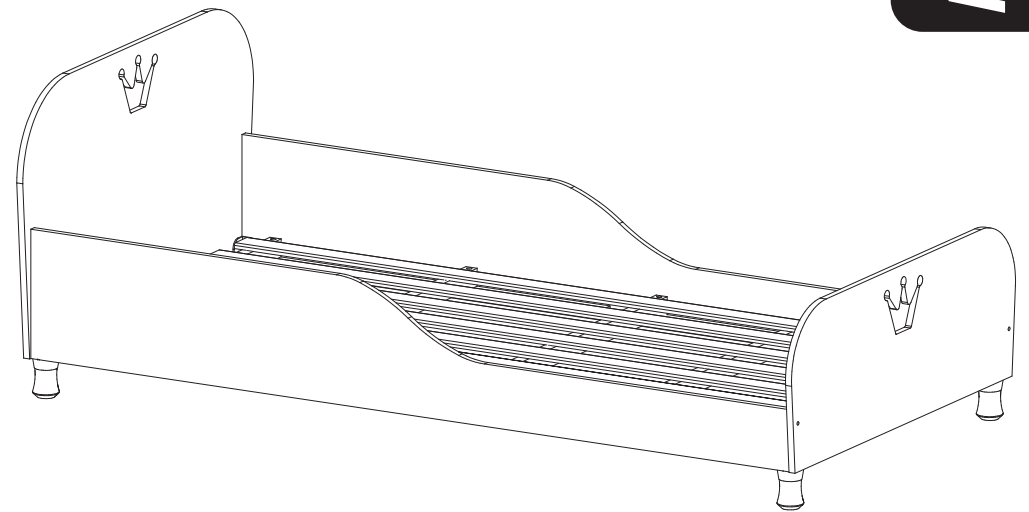



REF.: 2320

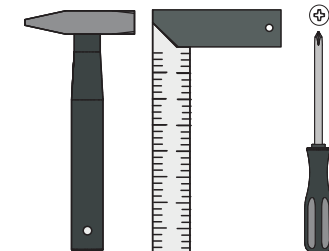
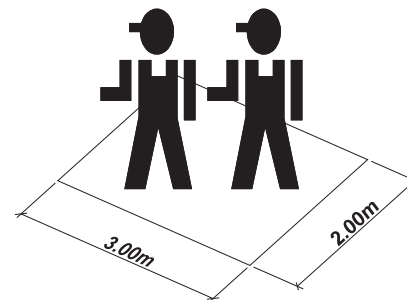

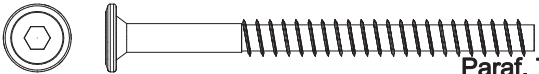
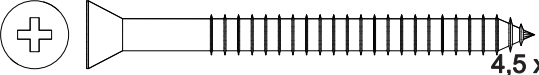
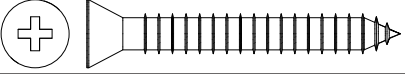
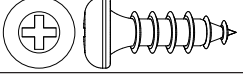
**MULTIMÓVEIS**  
*baby*

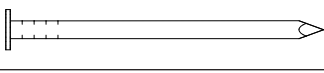
Rua Carlos Dreher Neto, 1918, Fone: (54) 2102 4000, FAX: (54) 2102 4050  
CEP 95700-000 - BENTO GONÇALVES - RS - BRASIL  
CNPJ: 00.349.443/0001-92  
e-mail: [multimoveis@multimoveis.com](mailto:multimoveis@multimoveis.com) / site: [www.multimoveis.com](http://www.multimoveis.com)



A		Paraf. 7,0x50	06
B		4,5 x 50	10
D		3,5 x 35	20
F		3,5 x 14	24
H		8,0 x 30	16
AU		13 x 15	35
BX		<b>COLA</b>	01
HV		SAPATA	04
BJ		TAMPA CPL	06
HP		Chave Allen Z 4mm	01

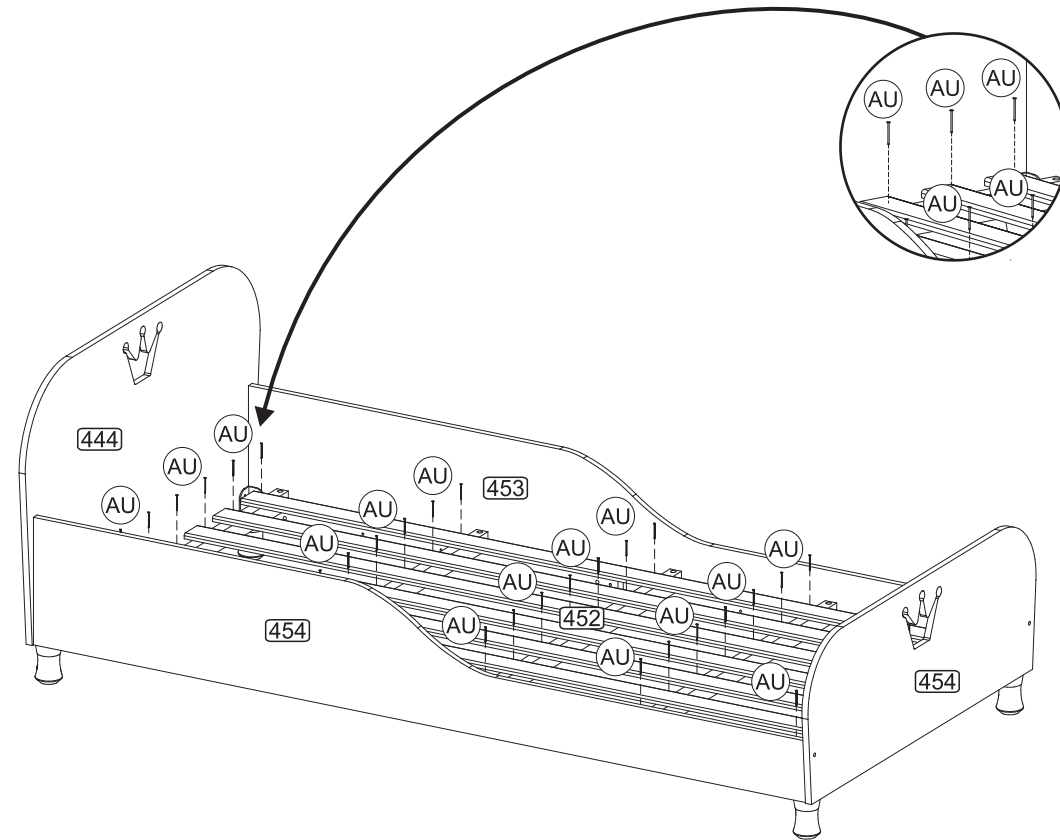

Utilizar a régua abaixo para medir as ferragens:

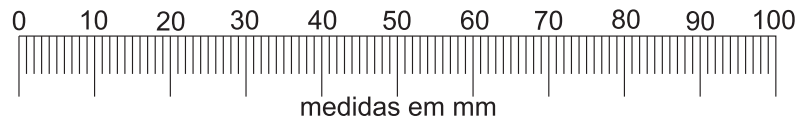

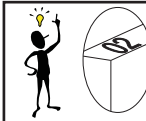

Senhor montador!  
Informamos que a numeração das peças encontra-se no topo das mesmas conforme desenho acima.

Señor Armador!  
Les informamos que la numeración de las piezas encuentranse arriba de las mismas, de acuerdo al modelo arriba.

Dear Assembler!  
We inform you that the number of each piece is located on the top of it, according to the model shown above.

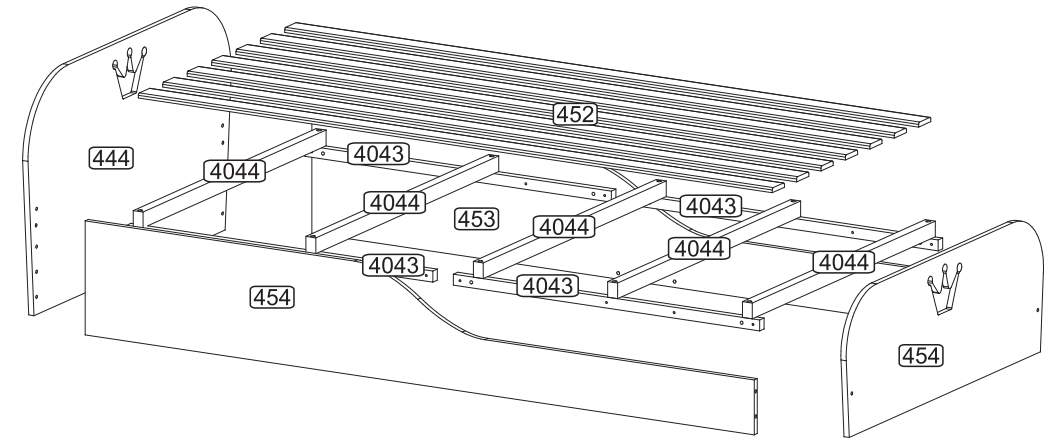
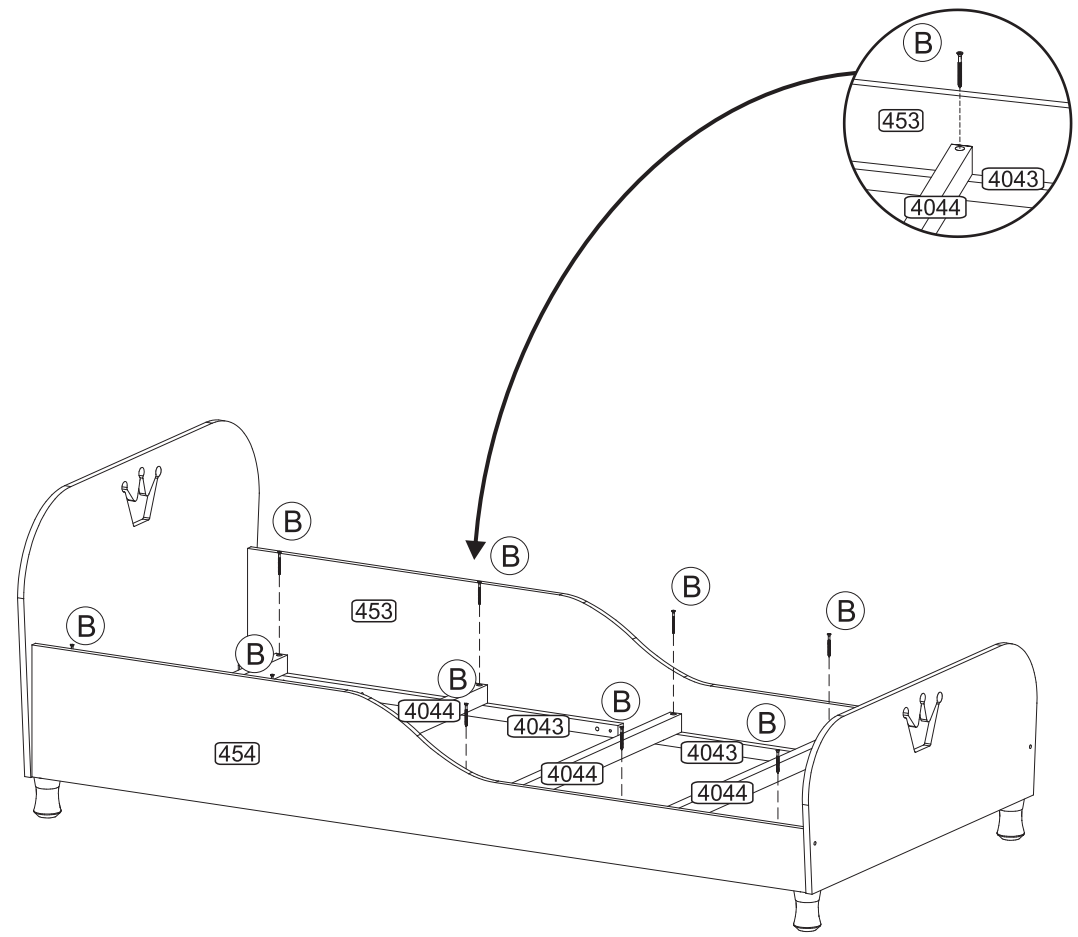

**LISTA DE PEÇAS**

Nº	DENOMINAÇÃO
452	LASTRO
444	CABECEIRA
451	PESEIRA
453	BARRA DE CAMA DIREITA
454	BARRA DE CAMA ESQUERDA
4043	SUPORTE P/ BARRA
4044	SUPORTE DE LASTRO

**LISTA DE PIEZAS**

Nº	DENOMINACIÓN
452	PARRILLA
444	CABECERA
451	PESERA
453	BARRA DE CAMA DERECHA
454	BARRA DE DE CAMA IZQUIERDA
4043	SOPORTE BARRA
4044	SOPORTE PARRILLA

**PART LIST**

Nº	DESCRIPTION
452	MATTRESS
444	HEAD BOARD
451	FOOTBOARD
453	RIGHT BAR BED
454	LEFT BAR BED
4043	BAR SUPPORT
4044	MATTRESS SUPPORT BAR

PRÉ-MONTAGEM / PRÉ-ARMADO / PRÉ-ASSEMBLAGE

Passo  
Paso  
Step **02**

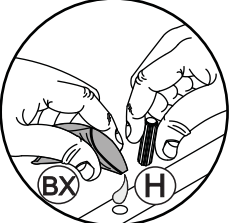
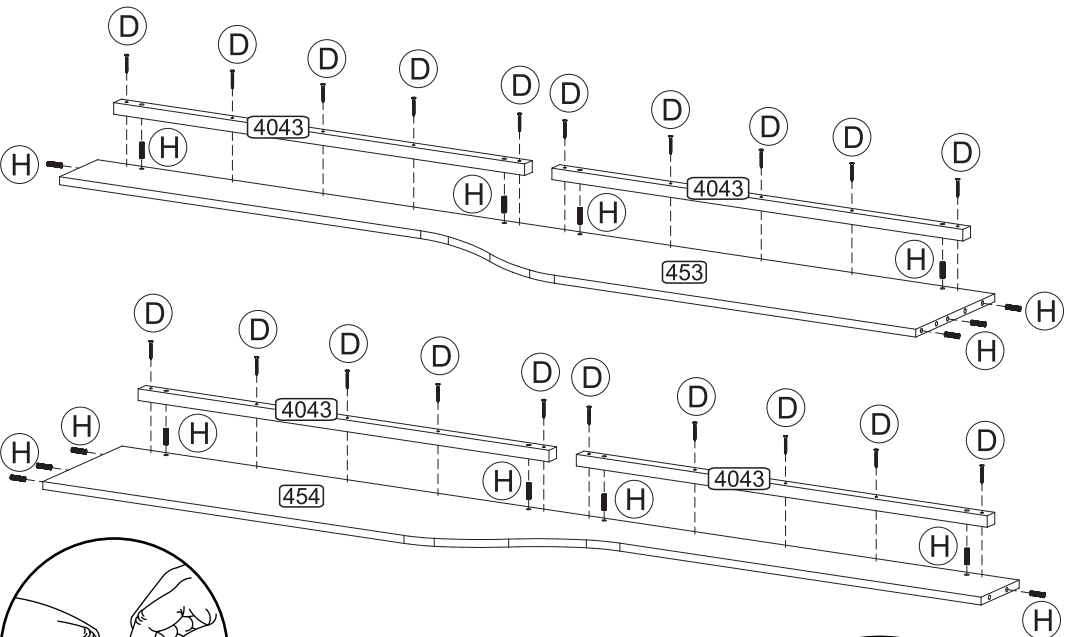

Passo  
Paso  
Step **01**

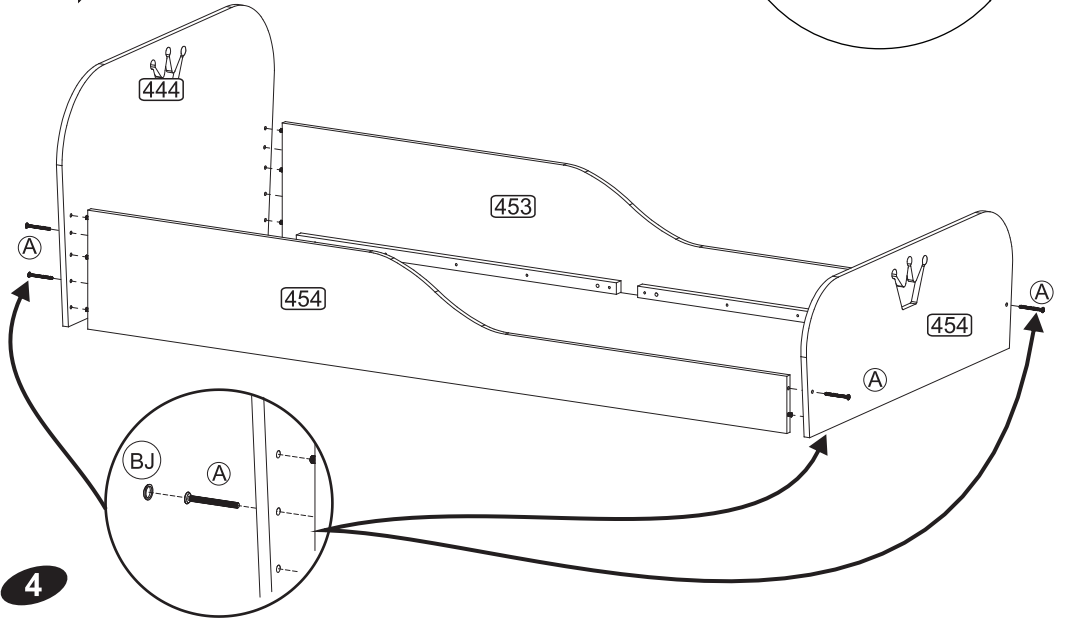

**4**

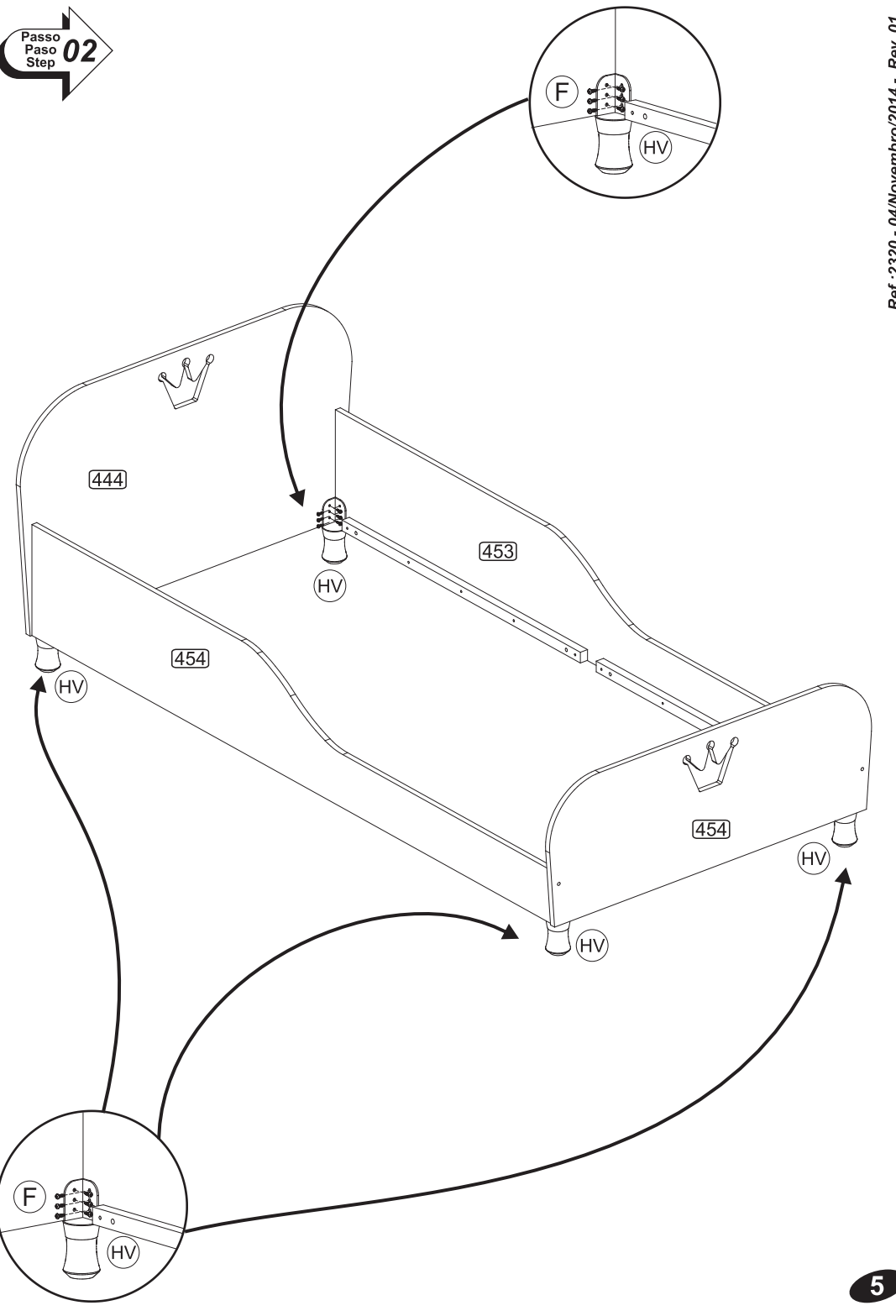

**5**