





















## Acessórios

-  Paraf. Ø4x45 mm  
Montagem estrutura 34
-  Par. Ø3,5x30 mm  
puxador e gavetas 42
-  Par. Ø3,5x14 mm  
P/cantoneiras,  
cabideiro, correções,  
Dobradiça e calço 246
-  Cavilha Ø6x30 mm  
Montagem estrutura  
Gavetas e rodapés 48
-  Ø26mm  
Dobradiça CURVA 18
-  Dobradiça RETA  
sapateira 2
-  Calço 5 (Baixo) 20
-  Pistão a gás  
FORÇA INVERSA...50 N 1
-  Puxador Klar 14
-  Suporte cabideiro 4
-  Correção  
(paraf. Ø4x14mm) 7 pares
-  Junção 24
-  Perfil H 390mm 2
-  Perfil H 2020mm 3
-  Cantoneira  
P/ Vistas, gavetas  
e rodapés internos 30
-  Suporte prateleira 8
-  Preço 13 x 15  
Gavetas 28
-  Preço 10 x 10  
Fundos 150
-  Cola branca(sache)  
P/cavilhas 2
-  Sapatas 8
-  Tapa-furo 4
-  Cabideiro  
Metal 2

## Montagem da Estrutura

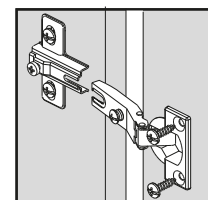
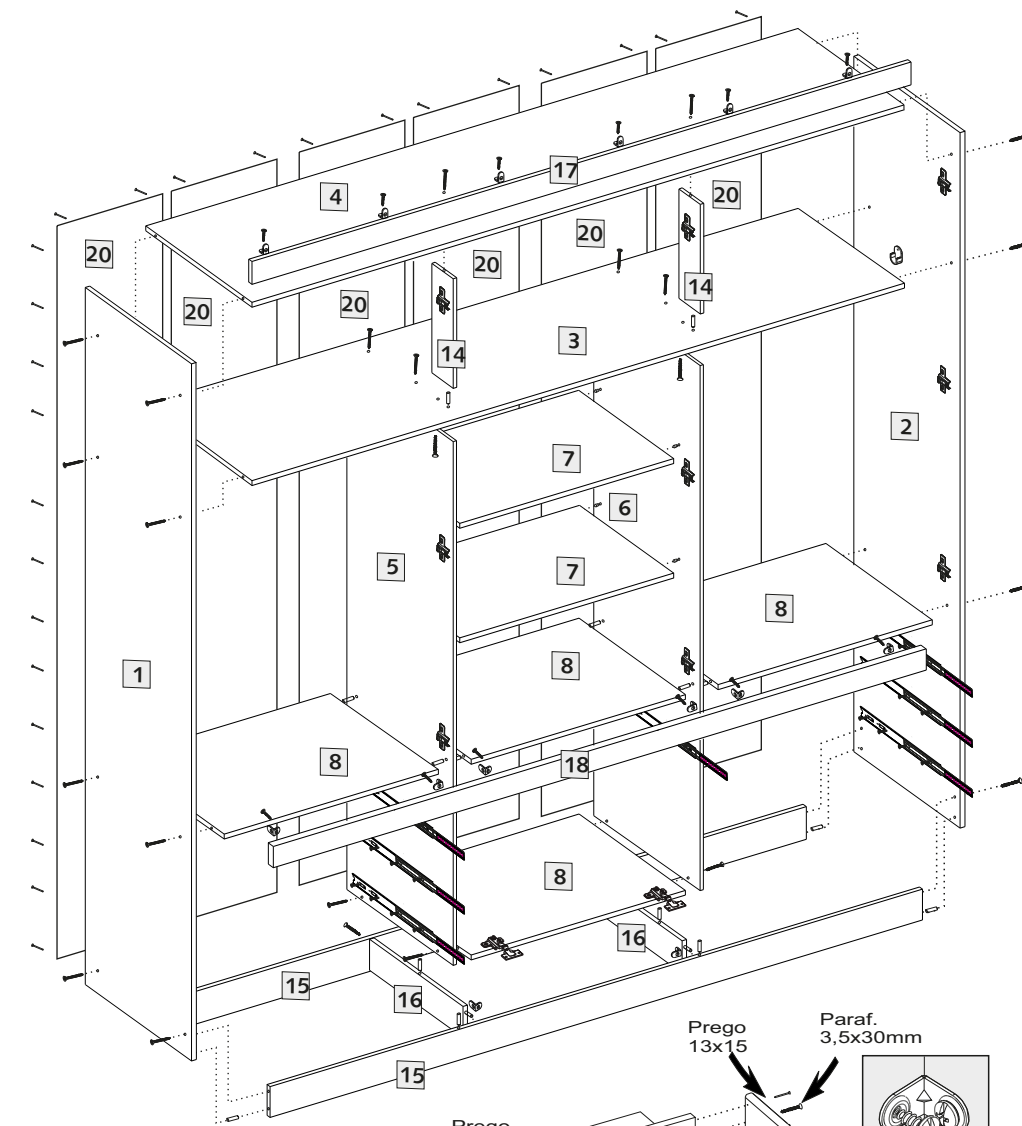

### Montagem do PISTÃO

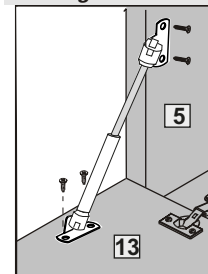

### FIXAÇÃO MOLDURA CENTRAL

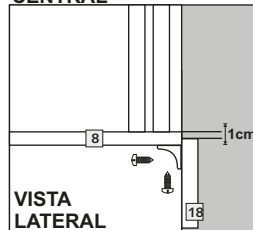

VISTA LATERAL

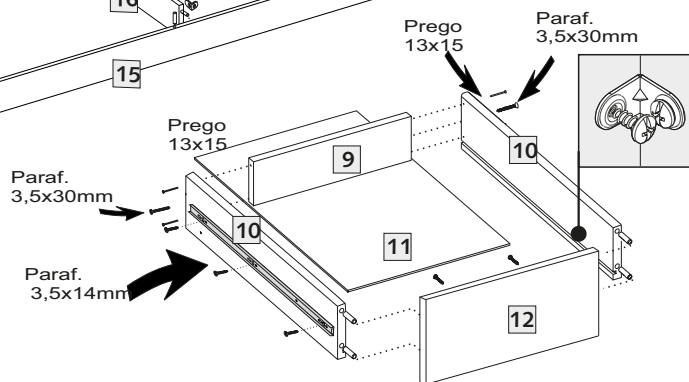

### Montagem das Gavetas

### FIXAÇÃO MOLDURA SUPERIOR

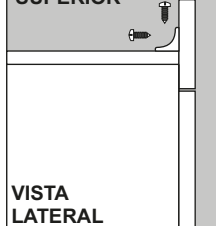

VISTA LATERAL

### ATENÇÃO!

Fixar a moldura superior de acordo com o desenho. Fixar pouco abaixo da linha do trilho superior.

## Roupeiro 6P 7 Gavetas 1 Sapateira FIRENZE

Larg.: 2340mm Alt.: 2180mm Prof.: 465mm

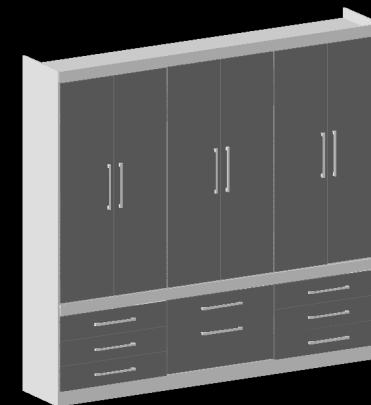

Item	Componente	QT.	ALT. X LARG.	Assist.Téc.
01	Lateral Esquerda	01	2180 x 450	
02	Lateral Direita	01	2180 x 450	
03	Base Maleiro	01	2310 x 450	
04	Chapéu	01	2310 x 450	
05	Divisão Principal esq.	01	1644 x 450	
06	Divisão Principal dir.	01	1644 x 450	
07	Prateleira Móvel	02	760 x 395	
08	Prateleira Fixa	04	760 x 450	
09	Traseira de gaveta	07	80 x 706	
10	Lateral de Gaveta	14	110 x 360	
11	Fundo de gaveta	07	722 x 365	
12	Frente de gaveta	07	160 x 770	
13	Frente Sapateira	01	322 x 770	
14	Divisão Maleiro	02	340 x 90	
15	Rodapé	02	2310 x 100	
16	Rodapé Interno	02	400 x 100	
17	Moldura Superior	01	2338 x 70	
18	Moldura Central	01	2320 x 70	
19	Portas	06	1430 x 384	
20	Fundos	06	2020 x 385	

### Conservação e Limpeza

Para a limpeza basta utilizar pano macio ligeiramente úmido.

Não use álcool ou abrasivos que poderão danificar a camada de verniz.



EUCAMÓVEIS