

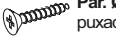

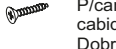



Acessórios

-  Paraf. Ø4x45 mm
Montagem estrutura 18
-  Par. Ø3,5x30 mm
puxador 4
-  Par. Ø3,5x14 mm
P/cantoneiras,
cabideiro,
Dobradiça, calço 32
-  Cavilha Ø6x30 mm
Montagem estrutura
e rodapés 2
-  Ø26mm
Dobradiça CURVA 6
-  Calço 5 (Baixo) 6
-  Puxador Klar 2
-  Suporte cabideiro 4
-  Cantoneira
P/ Moldura superior 2
-  Pregos 10 x 10
Fundos 40
-  Sapatas 4
-  Cabideiro
Metal 2

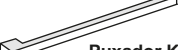
Montagem da Estrutura

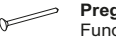

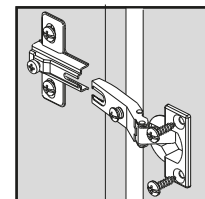
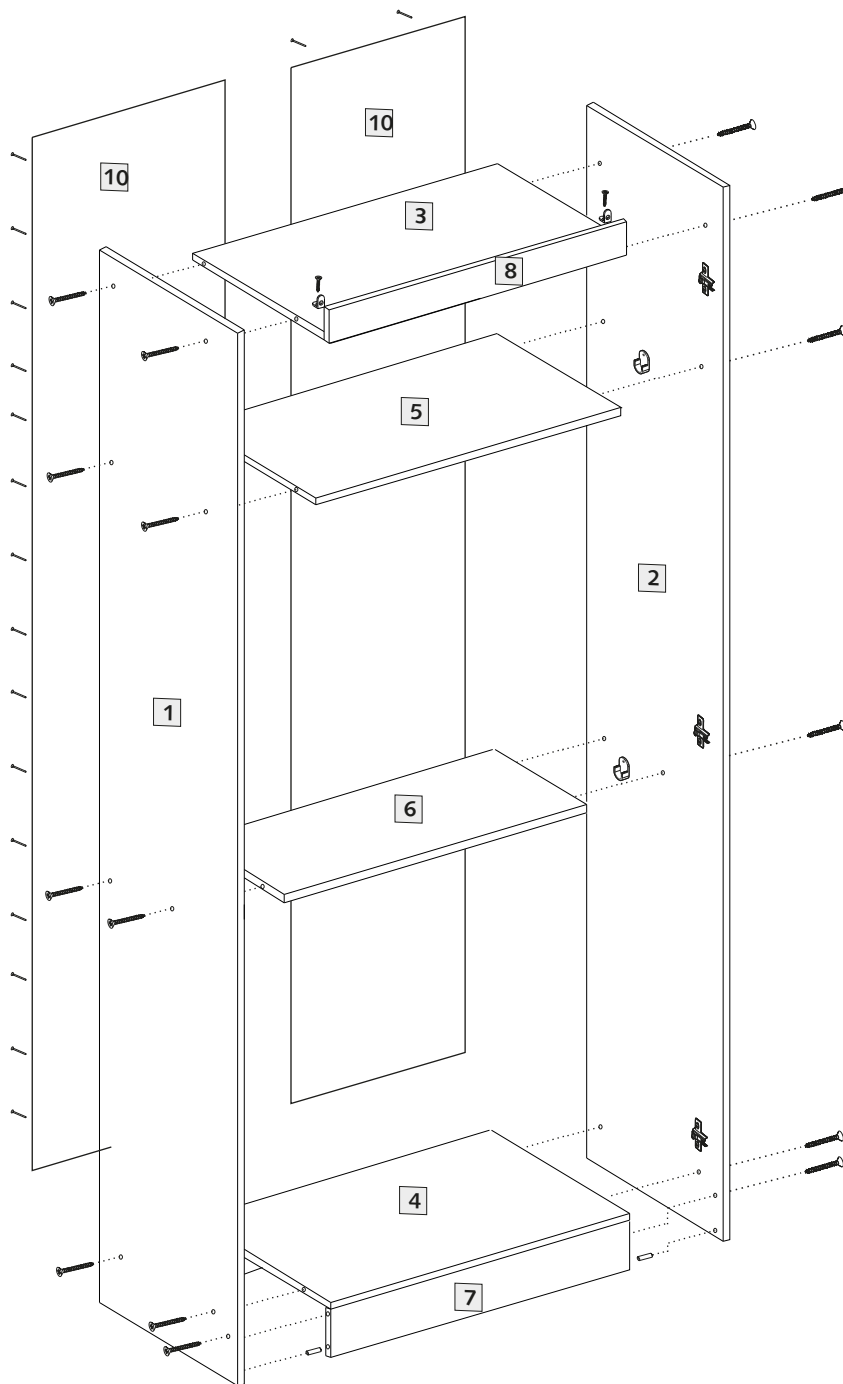
Roupeiro 2 Portas SMART

Larg.: 680mm Alt.: 2180mm Prof.: 465mm

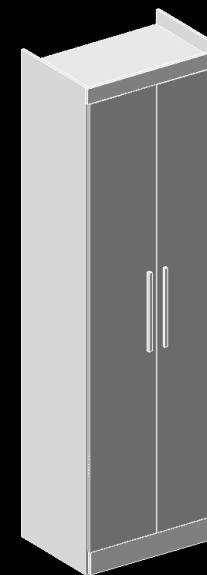

Item	Componente	QT.	ALT. X LARG.	Assist.Téc.
01	Lateral Esquerda	01	2180 x 450	
02	Lateral Direita	01	2180 x 450	
03	Chapéu	01	650 x 450	
04	Base	01	650 x 450	
05	Base Maleiro	01	650 x 450	
06	Prat. estreita	01	650 x 300	
07	Rodapé	01	100 x 650	
08	Moldura superior	01	70 x 680	
09	Porta	02	2005 x 328	
10	Fundos	02	2020 x 333	

FIXAÇÃO MOLDURA SUPERIOR



VISTA LATERAL

ATENÇÃO!

Fixar a moldura superior de acordo com o desenho.

Conservação e Limpeza

Para a limpeza basta utilizar pano macio ligeiramente úmido.
Não use álcool ou abrasivos que poderão danificar a camada de verniz.



EUCAMÓVEIS