

MANUAL DE MONTAGEM
Assembly instructions / Instrucciones de armado

ARMÁRIO AÉREO SLIM

Wall Cabinet Slim
Armario de pared Slim

Código 3315 | Revisão 05

NOTA: Este produto pode ser montado com a porta para a sua esquerda ou direita.
NOTE: This product can be assembled with door to left or right.
NOTA: Este producto se puede armar con la puerta a la izquierda o derecha.

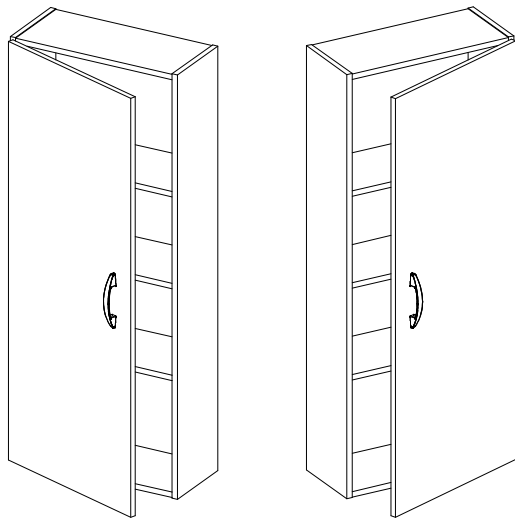

PESO MÁXIMO SUPORTADO PELAS PEÇAS, SENDO ESTE DISTRIBUÍDO UNIFORMEMENTE.
Maximum weight supported by parts, being this evenly distributed.
Peso máximo soportado por las partes, siendo esta distribuido uniformemente.

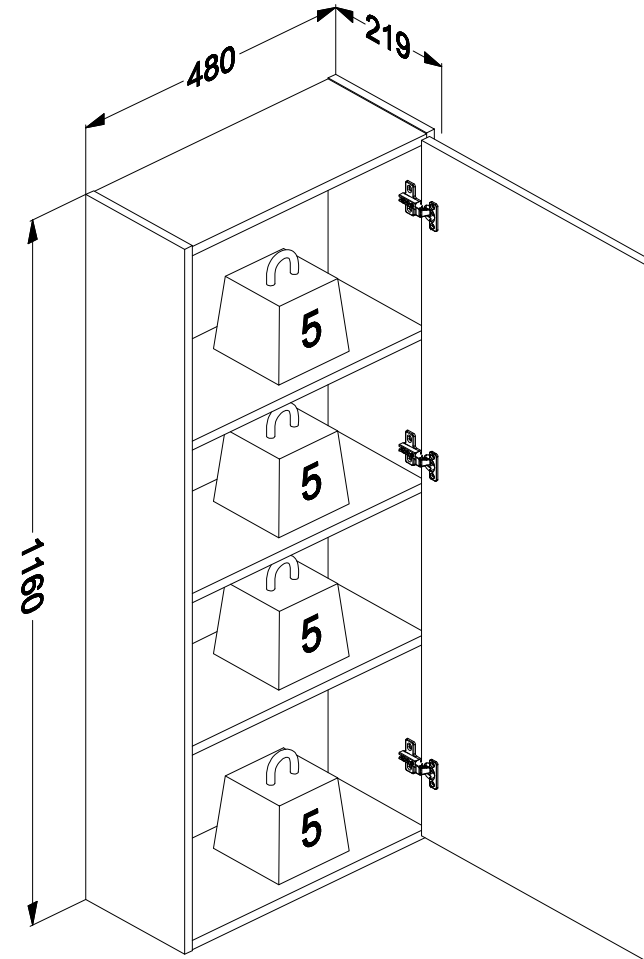

Você vai precisar de/ You will need / Usted necesitará

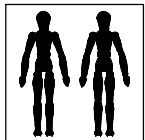

2 Pessoas
2 People
2 Personas

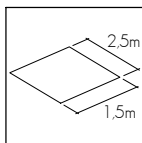

Espaço recomendado para montagem
Recommended space for assemble
Espacio recomendado para el armado

Ferramentas não inclusas
Tools not included / Herramientas no incluidas

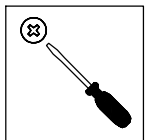

Chave Philips
Screwdriver
Destornillador cruz

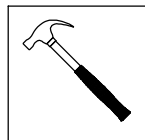

Martelo
Hammer
Martillo







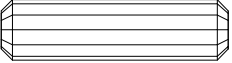
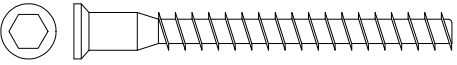

* PESO EM KG/ Weight in Kg/ Peso en Kg
DIMENSÕES EM MM/ Dimensions in mm/ Dimensiones en mm

IDENTIFICAÇÃO DOS ACESSÓRIOS / IDENTIFICATION OF ACCESSORIES/ IDENTIFICACIÓN DE ACCESORIOS

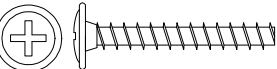
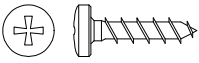
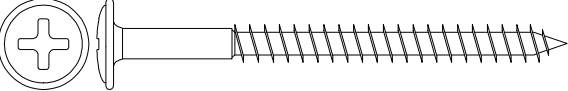
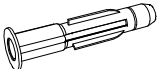
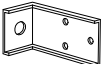
NOTAS: A separação dos acessórios antes de iniciar a montagem facilitará a mesma. Os parafusos e cavilhas estão na escala real. Em caso de dúvida na identificação, coloque o acessório sobre a imagem.

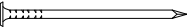
NOTES: The separation of the accessories before you start the assembly will facilitate the same. The screws and dowels are in real scale. In case of doubts about the identification, place the accessory on the image.

NOTAS: La separación de los accesorios antes de comenzar el armado facilitará el mismo. Los tornillos y taquetes son en escala real. En caso de dudas sobre la identificación, coloque el accesorio en la imagen.

A		Cavilha Wooden Dowel Pin	8x30 mm	20
B		Parafuso estrutural Structural screw Tornillo estructural	5,0x50 mm	06
C		Chave allen Allen key Llave Allen	-	01
D		Parafuso flangeado Flanged head screw Tornillo de cabeza flangeada	3,5x25 mm	02
E		Parafuso panela Pan head screw Tornillo de pan	3,5x14 mm	16
F		Parafuso flangeado Flanged head screw Tornillo de cabeza flangeada	5,0x60 mm	02
G		Bucha expansiva Bushing Tapón	8x50 mm	02
H		Suporte "L" Support "L" Soporte "L"	-	02
I		Dobradiça curva Metal hinge curve Esquina de bisagra metálica	26mm	03
J		Prego Nail Clavo	10 x10	45
K		Puxador Handle Tirador	-	01
L		Calço dobradiça Hinge shim Bisagra de calce	-	03
M		Capa Cover Cubierta	-	02
N		Tampa parafuso estrutural Structural screw cover Tapa tornillo estructural	-	06

IDENTIFICAÇÃO DAS PEÇAS/ PARTS IDENTIFICATION/ IDENTIFICACIÓN DE LAS PIEZAS

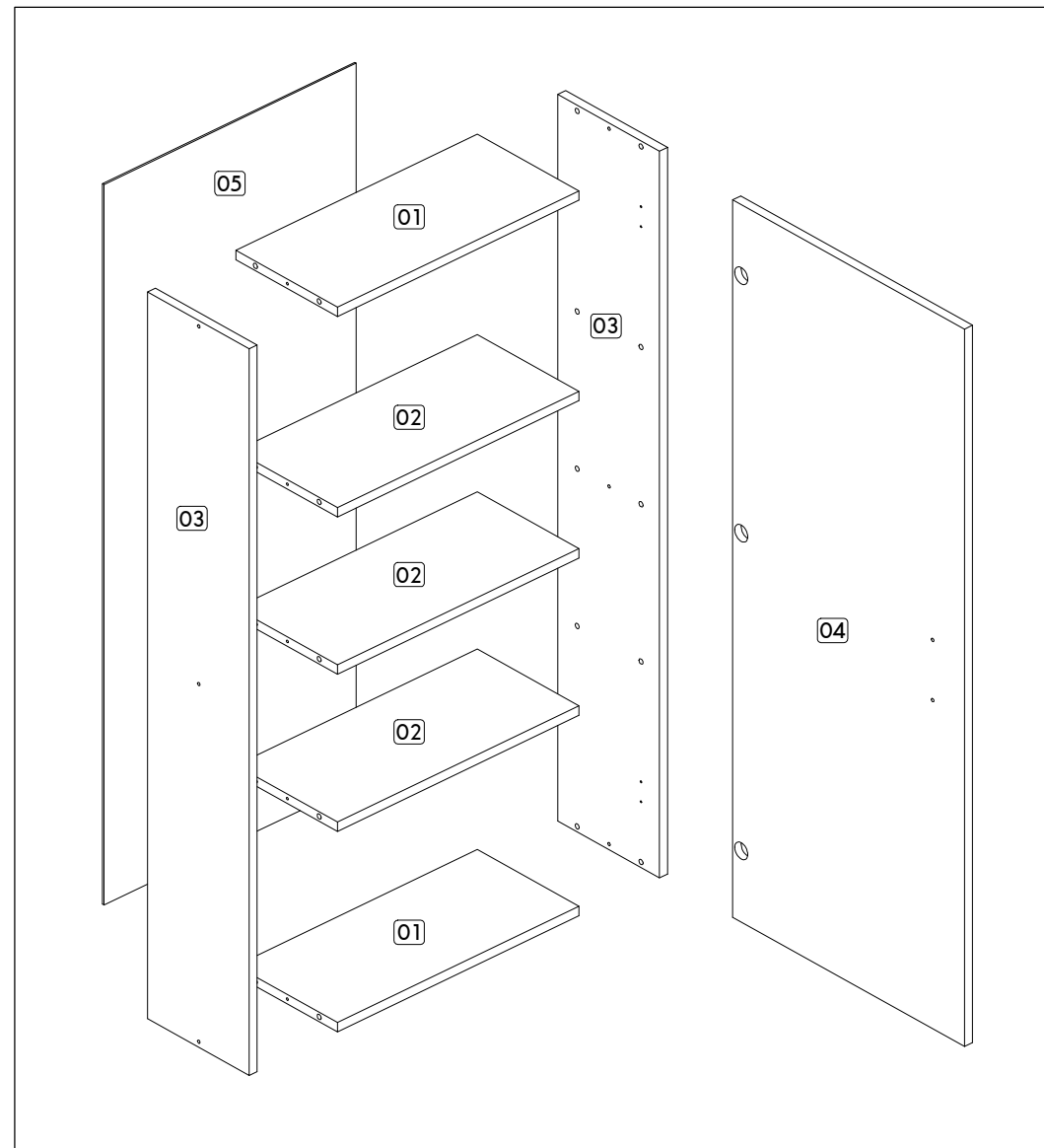

Nº	DESCRIÇÃO - DESCRIPTION - DESCRIPCIÓN	MEDIDAS-MEASURES - MEDIDAS (mm)	QTD.
01	Base superior/inferior - Upper/bottom Base - Base superior/inferior	450 x 204 x 15	02
02	Prateleira interna - Shelf - Repisa	450 x 204 x 15	03
03	Lateral direita/esquerda - Right/left side- Lateral izquierda/derecha	1160 x 204 x 15	02
04	Porta - Door - Puerta	1145 x 465 x 15	01
05	Costa - Back - Fondo	1150 x 470 x 03	01

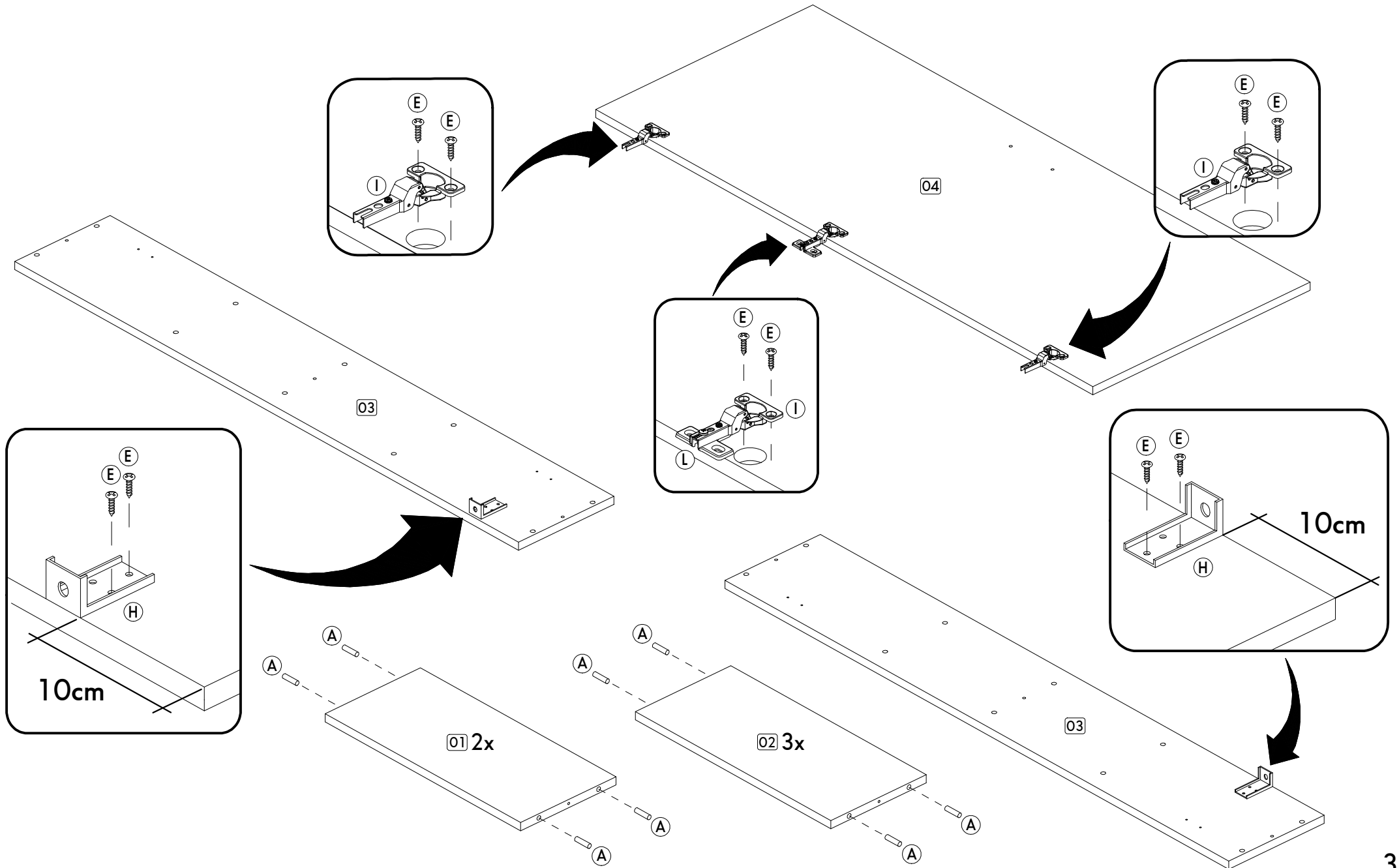

Passo/ Step/ Paso 01

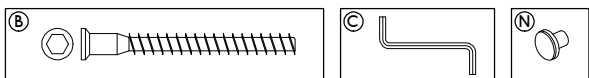
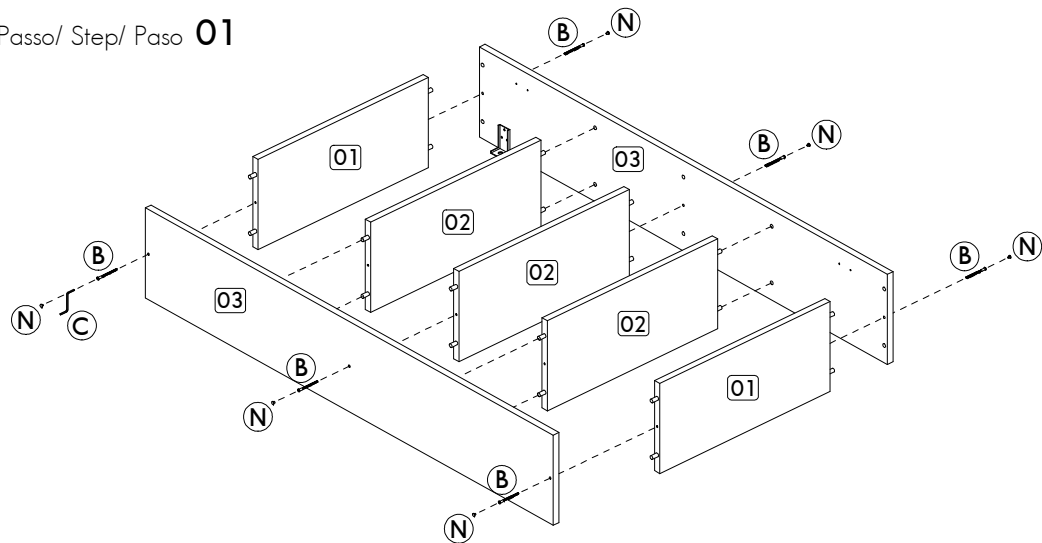

Passo/ Step/ Paso 02

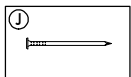
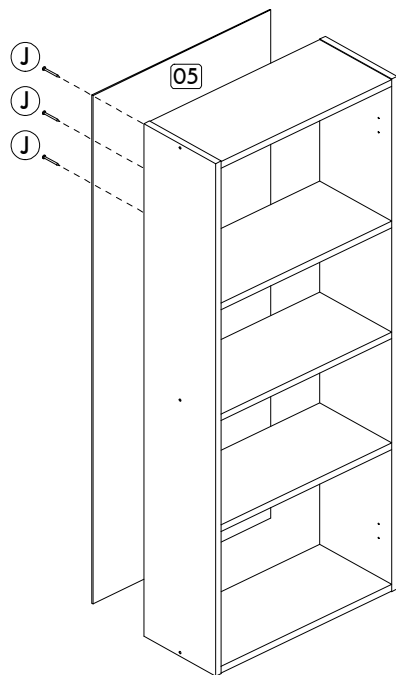

Passo/ Step/ Paso 03

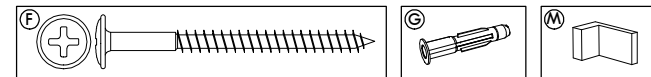
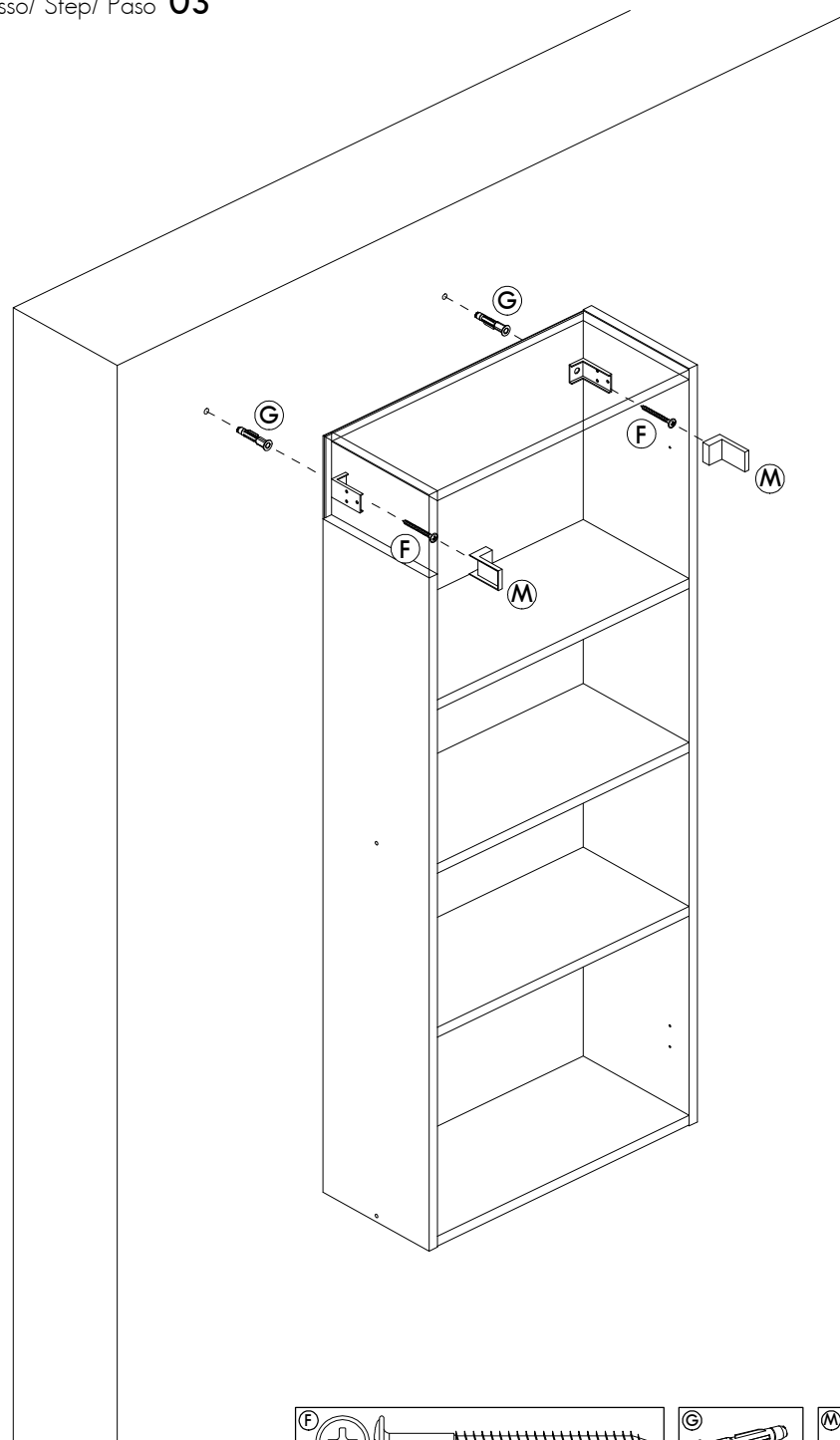

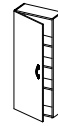

NOTA: Se optou por montar a porta para a direita, vá para a página 6.
NOTE: If you chose to install the door to the right, go to page 6.
NOTA: Si elegiste instalar la puerta a la derecha, ir a la página 6.

Passo/ Step/ Paso 04

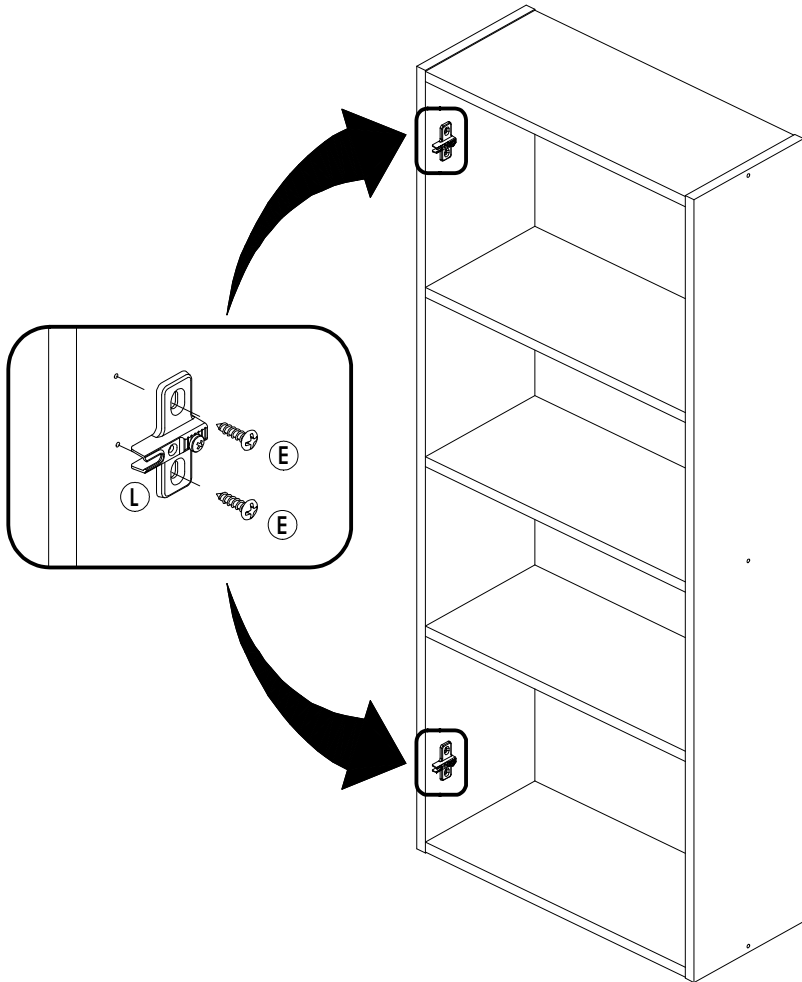

Passo/ Step/ Paso 05

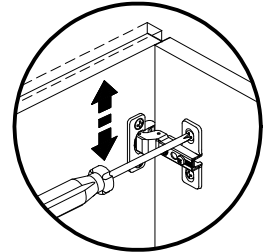
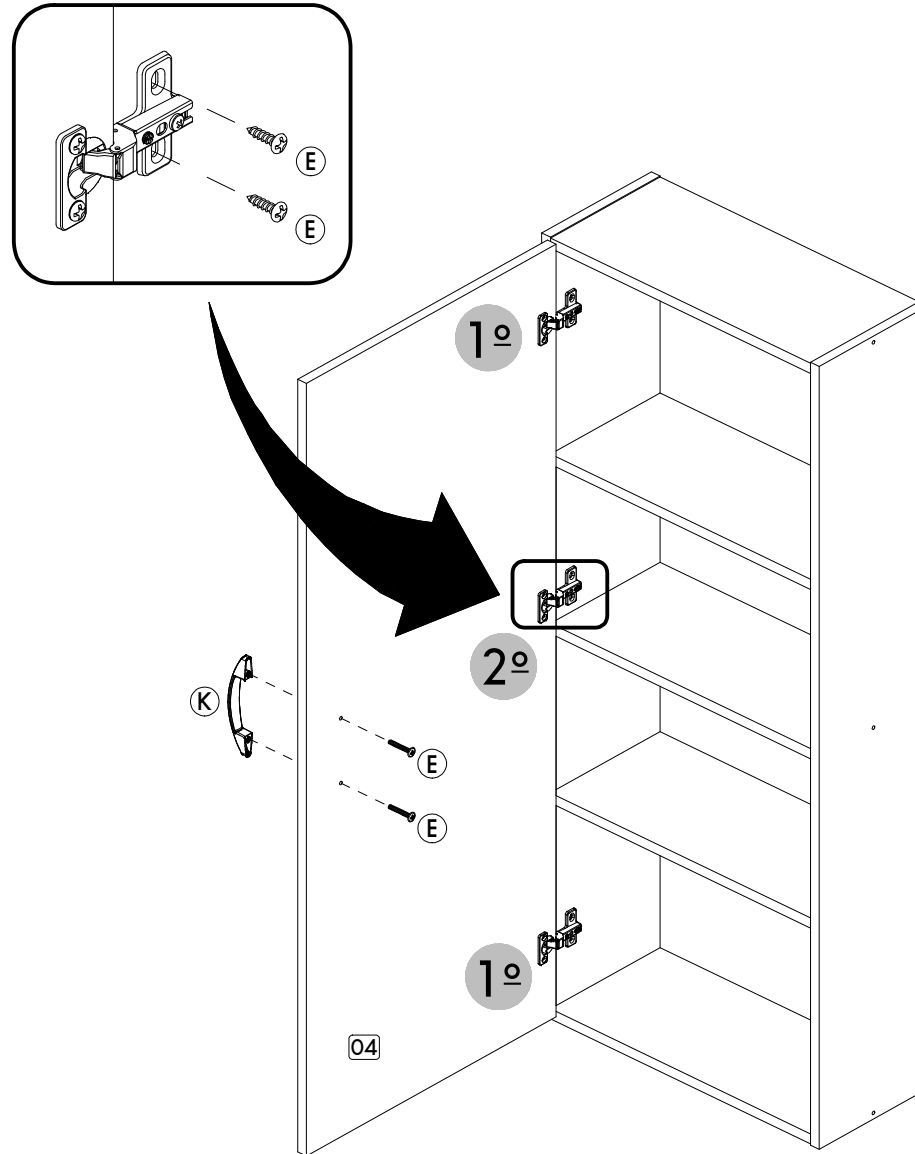

Regulagem Vertical
Ajuste Vertical
Vertical Adjustment

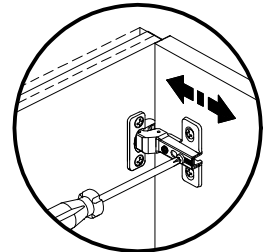

Regulagem Profundidade
Ajuste Profundidad
Depth Adjustment

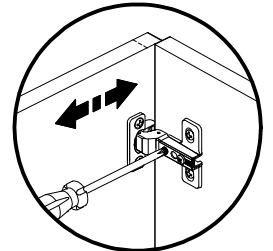

Regulagem Horizontal
Ajuste Horizontal
Horizontal Adjustment

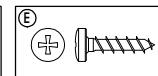
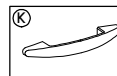
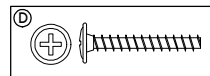
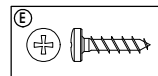

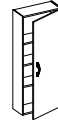

Passo/ Step/ Paso 04

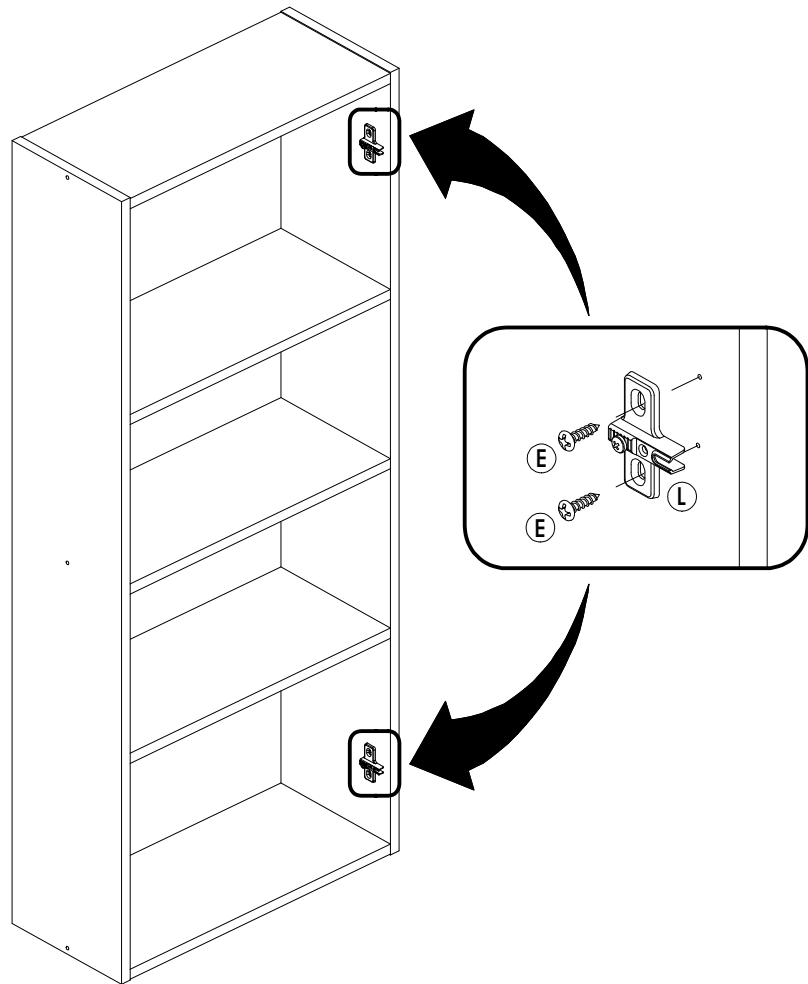

Passo/ Step/ Paso 05

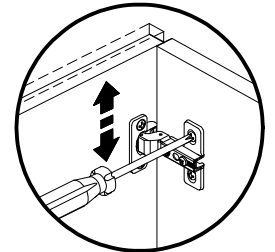
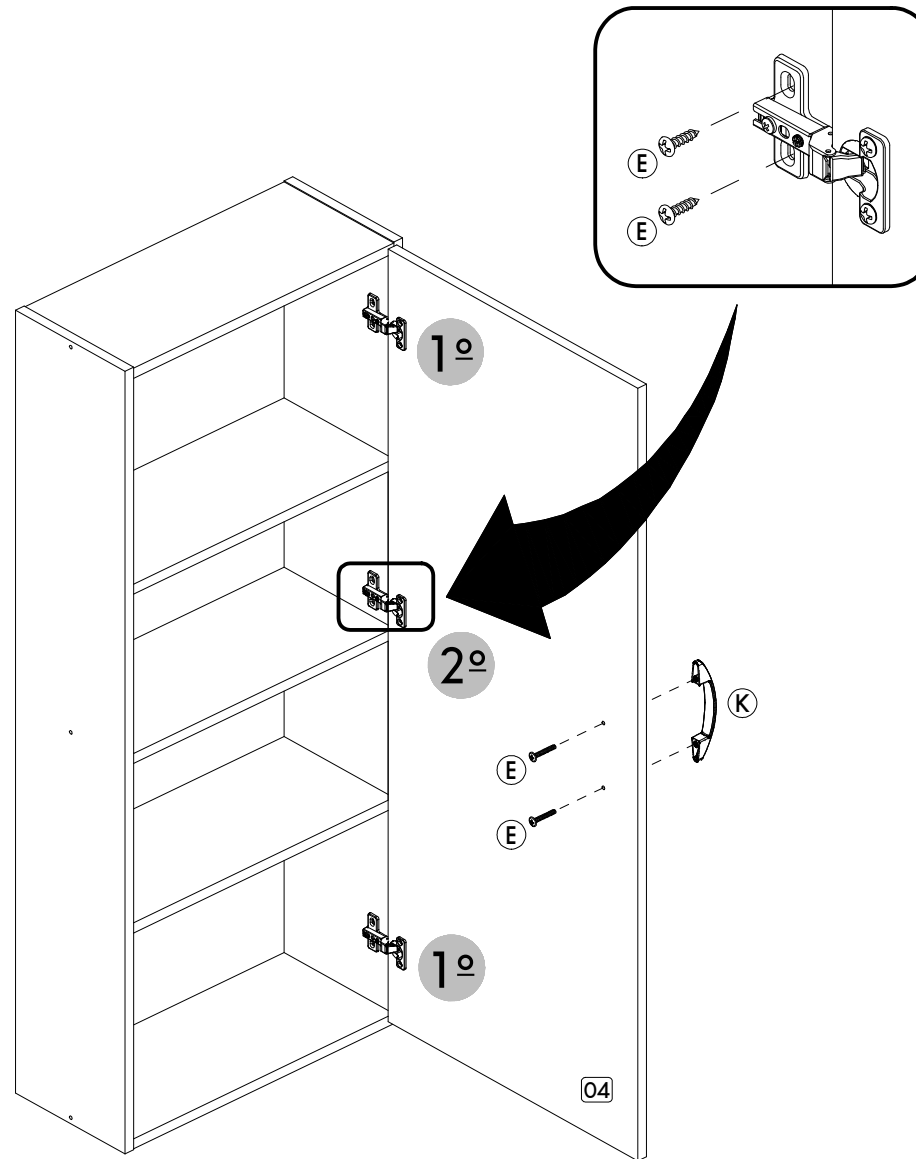

Regulagem Vertical
Ajuste Vertical
Vertical Adjustment

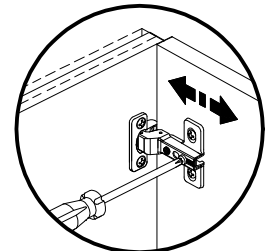

Regulagem Profundidade
Ajuste Profundidad
Depth Adjustment

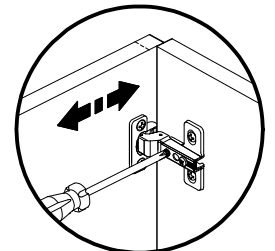

Regulagem Horizontal
Ajuste Horizontal
Horizontal Adjustment

