

# R - 1450

## Instruções de Montagem Instrucciones de Montaje

### Notas especiais:

- 01** - Examine completamente todas as peças do móvel antes de iniciar o trabalho.
- 02** - Recomenda-se montar o móvel conforme este Manual de Montagem.
- 03** - É de responsabilidade do montador seguir as instruções do Manual de Montagem, que são fundamentais para garantir a estrutura do móvel.
- 04** - Para limpeza utilizar somente pano úmido e sabão neutro.

### Notas especiales:

- 01** - Examine completamente todas las piezas del mueble antes de iniciar el trabajo.
- 02** - Se recomienda montar el mueble conforme el Manual de Esamblaje.
- 03** - Es de responsabilidad del montador seguir las instrucciones del Manual de Esamblaje, que son fundamentales para garantizar la estructura del mueble.
- 04** - Para limpieza solamente usar trapo húmedo y jabón neutro.



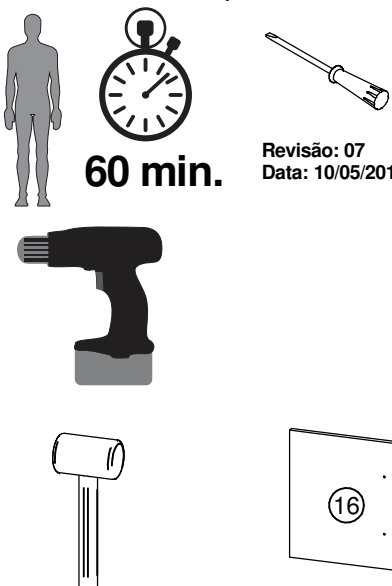





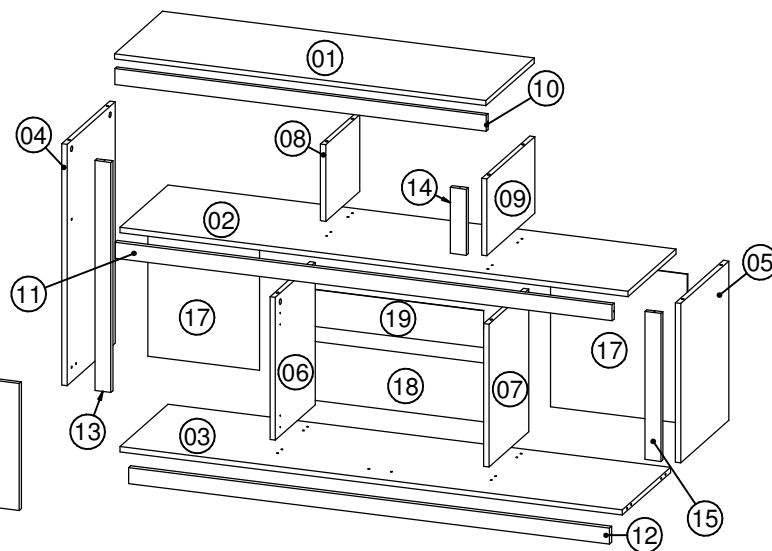

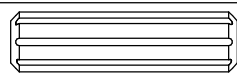

### Ferramentas | Herramientas

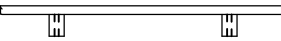

### Lista de peças / Lista de piezas

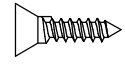
CÓD	DESCRIÇÃO	DESCRIPCIÓN	QTD	M. PRIMA	DIMENSÕES
01	Tampo Superior	Tapa Superior	1	MDP 15mm	1050 x 360 x 15
02	Tampo Intermediário	Tapa Intermediaria	1	MDP 15mm	1436 x 360 x 15
03	Base	Base	1	MDP 15mm	1420 x 360 x 15
04	Lateral Esquerda	Lateral Izquierda	1	MDP 15mm	677 x 360 x 15
05	Lateral Direita	Lateral Derecha	1	MDP 15mm	447 x 360 x 15
06	Divisão Esquerda	Division Izquierda	1	MDP 15mm	400 x 298 x 15
07	Divisão Direita	Division Derecha	1	MDP 15mm	400 x 298 x 15
08	Divisão Superior	Division Superior	1	MDP 15mm	255 x 215 x 15
09	Lateral Superior	Lateral Superior	1	MDP 15mm	360 x 215 x 15
10	Travessa Superior	Traviesa Superior	1	MDP 15mm	1050 x 45 x 15
11	Travessa Frontal	Traviesa Frontal	1	MDP 15mm	1405 x 45 x 15
12	Travessa Maior	Traviesa Mayor	1	MDP 15mm	1360 x 45 x 15
13	Travessa Esquerda	Traviesa Izquierda	1	MDP 15mm	645 x 45 x 15
14	Travessa Menor	Traviesa Menor	1	MDP 15mm	185 x 45 x 15
15	Travessa Direita	Traviesa Derecha	1	MDP 15mm	415 x 45 x 15
16	Porta	Puerta	2	MDP 15mm	356 x 298 x 15
17	Costa	Revés	2	Chapa Dura 3mm	418 x 418 x 3
18	Costa Central Inferior	Revés Central Inferior	1	Chapa Dura 3mm	604 x 300 x 3
19	Costa Central Superior	Revés Central Superior	1	Chapa Dura 3mm	604 x 120 x 3



REF	DESCRIÇÃO	QTD
<b>A</b>	 8x30mm	<b>12</b>
<b>B</b>	 Parafuso Minifix	<b>18</b>
<b>C</b>	 Rodízios 55 mm	<b>06</b>
<b>D</b>	 Dobradiça Caneco 26mm	<b>04</b>
<b>E</b>	 Puxador Cromado 160mm	<b>02</b>
<b>F</b>	 3,5 x 14 mm CC	<b>40</b>
<b>G</b>	 4 x 35 mm CC	<b>12</b>
<b>H</b>	 Suporte Angular	<b>21</b>
<b>I</b>	 3,5 x 14 mm FL	<b>42</b>
<b>J</b>	 Sup. Prateleira 8 x 10	<b>02</b>
<b>K</b>	 Pregos	<b>40</b>
<b>L</b>	 Tambor Minifix	<b>18</b>

