

ME - 4114

Instruções de Montagem Instrucciones de Montaje

tecnobili
Estrada RSC 453, Km s/nº | Garibaldi | RS
CEP: 95720-000 | Fone / Fax: 54.3463.8508

Notas especiais:











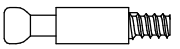

- 01** - Examine completamente todas as peças do móvel antes de iniciar o trabalho.
- 02** - Recomenda-se montar o móvel conforme este Manual de Montagem.
- 03** - É de responsabilidade do montador seguir as instruções do Manual de Montagem, que são fundamentais para garantir a estrutura do móvel.
- 04** - Para limpeza utilizar somente pano úmido e sabão neutro.

Notas especiales:

- 01** - Examine completamente todas las piezas del mueble antes de iniciar el trabajo.
- 02** - Se recomienda montar el mueble conforme el Manual de Esamblaje.
- 03** - Es de responsabilidad del montador seguir las instrucciones del Manual de Ensamblaje, que son fundamentales para garantizar la estructura del mueble.
- 04** - Para limpieza solamente usar trapo húmedo y jabón neutro.

Lista de peças / Lista de piezas

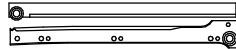
CÓD	DESCRIÇÃO	QTD	M. PRIMA
01	Tampo	1	MDP 15mm
02	Base	1	MDP 15mm
03	Lateral Direita	1	MDP 15mm
04	Lateral Esquerda	1	MDP 15mm
05	Prateleira Móvel	2	MDP 15mm
06	Rodapé	2	MDP 15mm
07	Porta de Vidro	2	MDP15mm
08	Frente Gaveta	3	MDP 15mm
09	Lateral Gaveta	6	MDP 15mm
10	Costa Gaveta	3	MDP 15mm
11	Fundo Gaveta	3	Chapa Dura 3mm
12	Perfil I	1	
13	Costa	2	Chapa Dura 3mm

REF	DESCRIÇÃO	QTD
A	 Parafuso minifix	24
B	 Tambor minifix	24
C	 Parafuso 3,5 x 30mm CP	05
D	 Parafuso 3,5 x 16mm CC	28
E	 Pregos 10 x 10mm	45
F	 Suporte de prateleira	08
G	 Sapata Deslizadora	04
H	 Cavilha 8 x 30mm	16
I	 Puxador	05
J	 Dobradiça Caneco 26 RETA	04
K	 Corrediça 300mm	03
L	 Parafuso 3,5 x 14mm CF Em baixo das gavetas	12

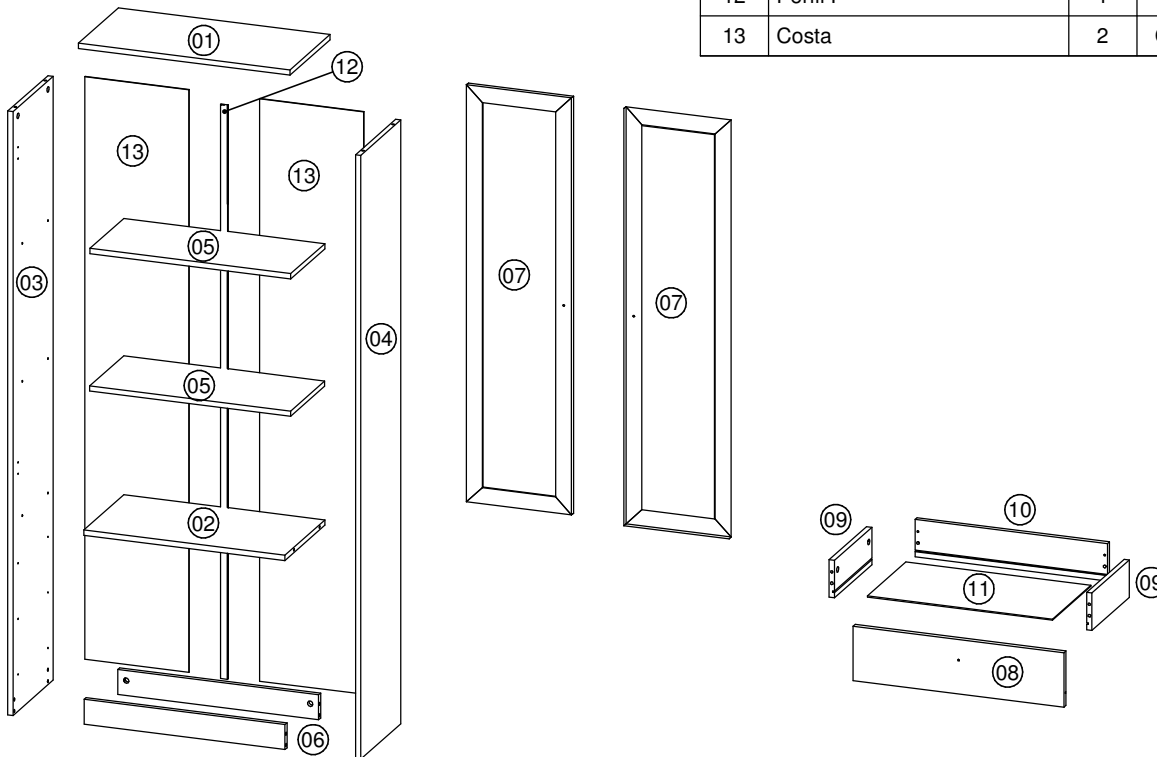

Ferramentas | Herramientas

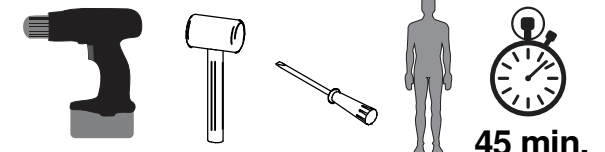

Data: 14/04/2014
Revisão: 00

