

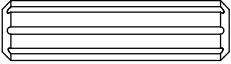









AM - 3100

Instruções de Montagem Instrucciones de Montaje

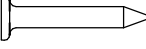
tecnobili

Estrada RSC 453, Km s/nº | Garibaldi | RS
CEP: 95720-000 | Fone / Fax: 54.3463.8508

REF	DESCRIÇÃO	QTD
A	 8x30mm	14
B	 3,5x14mm CC	30
C	 3,5x30mm CP	01
D	 3,3x35mm CC	08
E		04
F		04
G		03
H	 Prego 10x10	22
I		01
J		01
L		04

Lista de peças / Lista de piezas

CÓD	DESCRIÇÃO	QTD	M. PRIMA	DIMENSÕES
01	Base	2	MDP 15mm	450 x 385 x 15mm
02	Lateral Esquerda	1	MDP 15mm	1820 x 385 x 15mm
03	Lateral Direita	1	MDP 15mm	1820 x 385 x 15mm
04	Prateleira Superior	1	MDP 15mm	418 x 360 x 15mm
05	Lateral Interna	1	MDP 15mm	600 x 244 x 15mm
06	Base Menor	1	MDP 15mm	244 x 244 x 15mm
07	Porta	1	MDP 15mm	1830 x 428 x 15mm
08	Costa	1	Chapa 3mm	1840 x 437 x 3mm

Notas especiais:

- 01** - Examine completamente todas as peças do móvel antes de iniciar o trabalho.
- 02** - Recomenda-se montar o móvel conforme este Manual de Montagem.
- 03** - É de responsabilidade do montador seguir as instruções do Manual de Montagem, que são fundamentais para garantir a estrutura do móvel.
- 04** - Para limpeza utilizar somente pano úmido e sabão neutro.

Notas especiales:

- 01** - Examine completamente todas las piezas del mueble antes de iniciar el trabajo.
- 02** - Se recomienda montar el mueble conforme el Manual de Ensamblaje.
- 03** - Es de responsabilidad del montador seguir las instrucciones del Manual de Ensamblaje, que son fundamentales para garantizar la estructura del mueble.
- 04** - Para limpieza solamente usar trapo húmedo y jabón neutro.

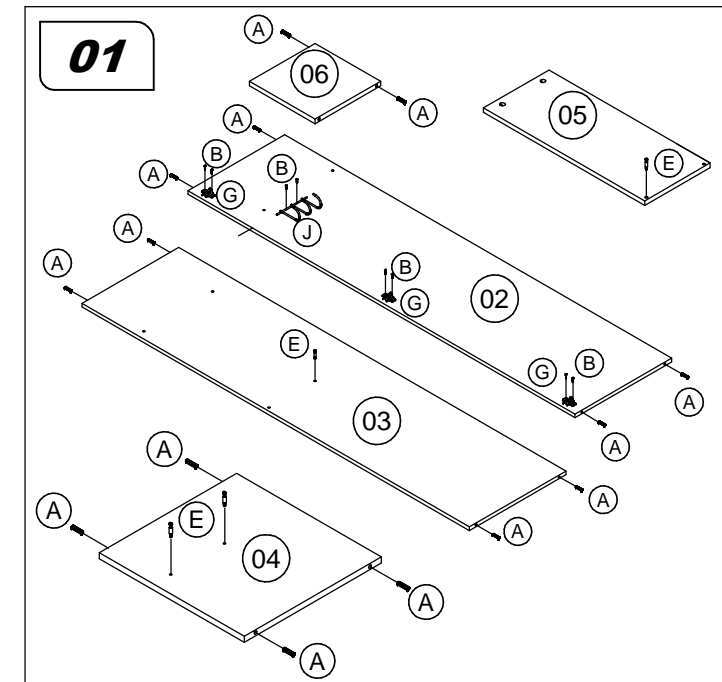
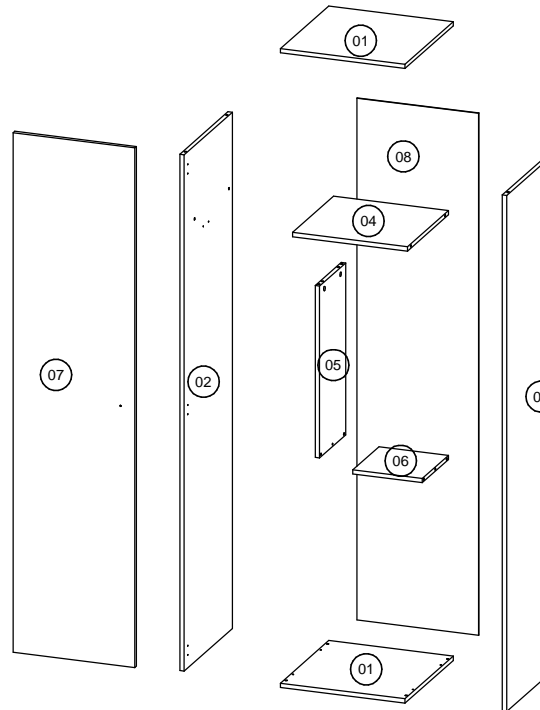

Ferramentas | Herramientas

Revisão: 04
Data: 16/03/2012

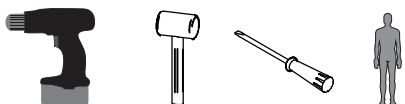

30 min.

