

GAVETEIRO MAUÁ - 4 GAVETAS

Drawer cabinet **Mauá** - 4 drawers
Cajonera **Mauá** - 4 cajones

Código **3420** | Revisão 02

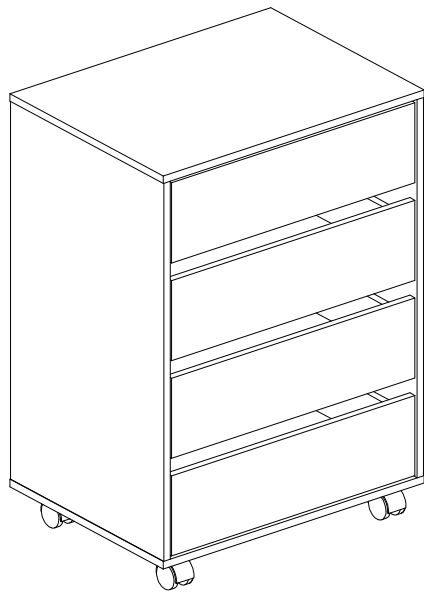

PESO MÁXIMO SUPORTADO PELAS PEÇAS, SENDO ESTE DISTRIBUÍDO UNIFORMEMENTE.

Maximum weight supported by parts, being this evenly distributed.

Peso máximo soportado por las partes, siendo esta distribuido uniformemente.

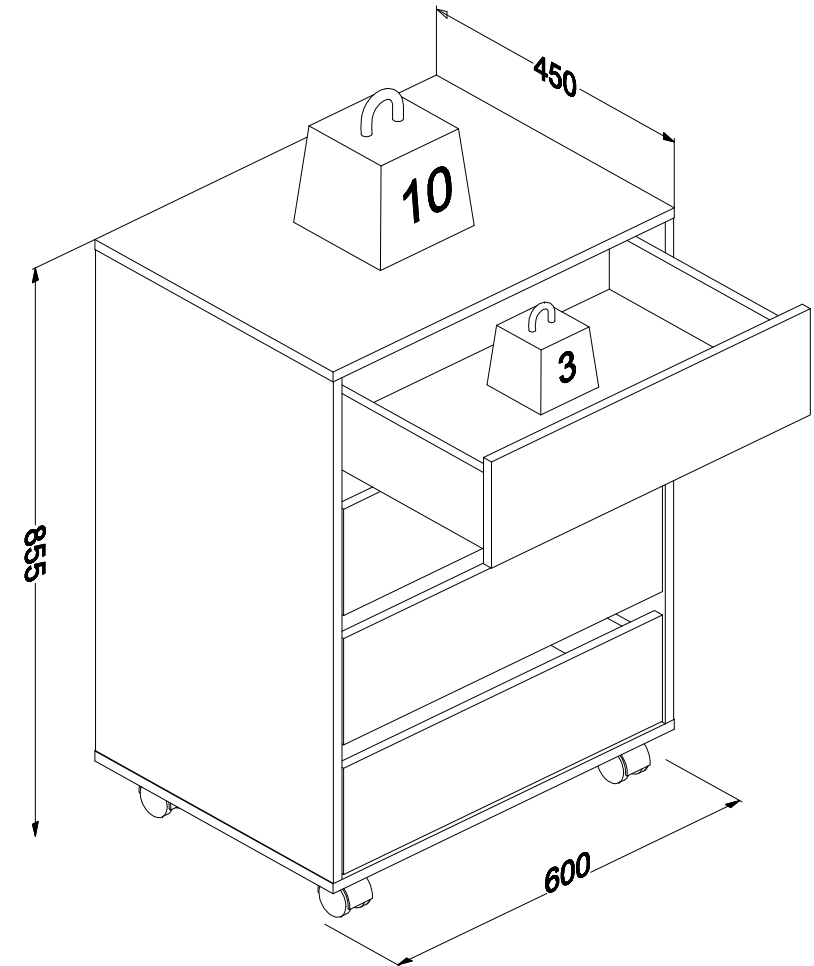

Você vai precisar de/ You will need / Usted necesitará

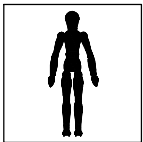

1 Pessoa
1 Person
1 Persona

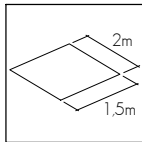

Espaço recomendado para montagem
Recommended space for assemble
Espacio recomendado para el armado

Ferramentas não inclusas
Tools not included / Herramientas no incluidas

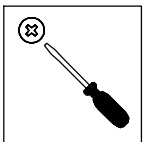

Chave Philips
Screwdriver
Destornillador cruz

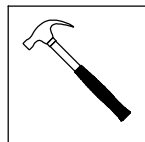











Martelo
Hammer
Martillo

* **PESO EM KG/ Weight in Kg/ Peso en Kg**

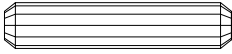
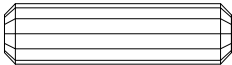
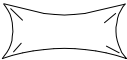
DIMENSÕES EM MM/ Dimensions in mm/ Dimensiones en mm

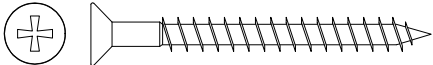
IDENTIFICAÇÃO DOS ACESSÓRIOS/ IDENTIFICATION OF ACCESSORIES/ IDENTIFICACIÓN DE ACCESORIOS

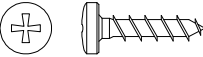
NOTAS: A separação dos acessórios antes de iniciar a montagem facilitará a mesma. Os parafusos e cavilhas estão na escala real. Em caso de dúvida na identificação, coloque o acessório sobre a imagem.
NOTES: The separation of the accessories before you start the assembly will facilitate the same. The screws and dowels are in real scale. In case of doubts about the identification, place the accessory on the image.
NOTAS: La separación de los accesorios antes de comenzar el armado facilitará el mismo. Los tornillos y taquetes son en escala real. En caso de dudas sobre la identificación, coloque el accesorio en la imagen.

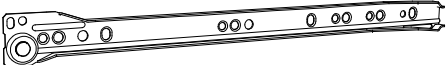
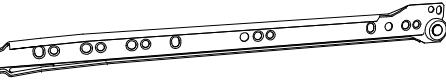
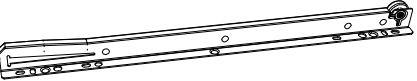
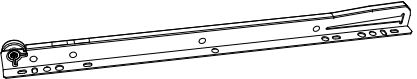
A		Haste minifix simples Simple minifix screw Tornillo minifix simple	-	12	13		Rodizio Caster Ruedas	-	04
B		Tambor minifix Drum lock Tambor minifix	12 mm	12					
C		Tapa furo adesivo Bore patch adhesive Tapones adhesivo	-	08					
D		Cavilha Wooden Dowel Pin	6x30 mm	32					
E		Cavilha Wooden Dowel Pin	8x30 mm	08					
F		Cola Glue Pegamento	13g	01					
G		Parafuso chato Flat head screw Tornillo de cabeza plana	3,0x14 mm	32					
H		Parafuso chato Flat head screw Tornillo de cabeza plana	4,5x45 mm	12					
I		Prego Nail Clavo	10 x10	30					
J		Parafuso panela Pan head screw Tornillo de pan	3,5x14 mm	16					
11		Perfil "H" "H" profile Perfil "H"	-	01					
12A		Corrediça lateral esquerda Metallic slide the left field Corredera lateral izquierda	350 mm	04					
12B		Corrediça lateral direita Metallic slide the right field Corredera lateral derecha	350 mm	04					
12C		Corrediça gaveta esquerda Drawer slide left Corredera izquierda cajón	350 mm	04					
12D		Corrediça gaveta direita Drawer slide right Corredera derecha cajón	350 mm	04					

IDENTIFICAÇÃO DAS PEÇAS/ PARTS IDENTIFICATION/ IDENTIFICACIÓN DE LAS PIEZAS

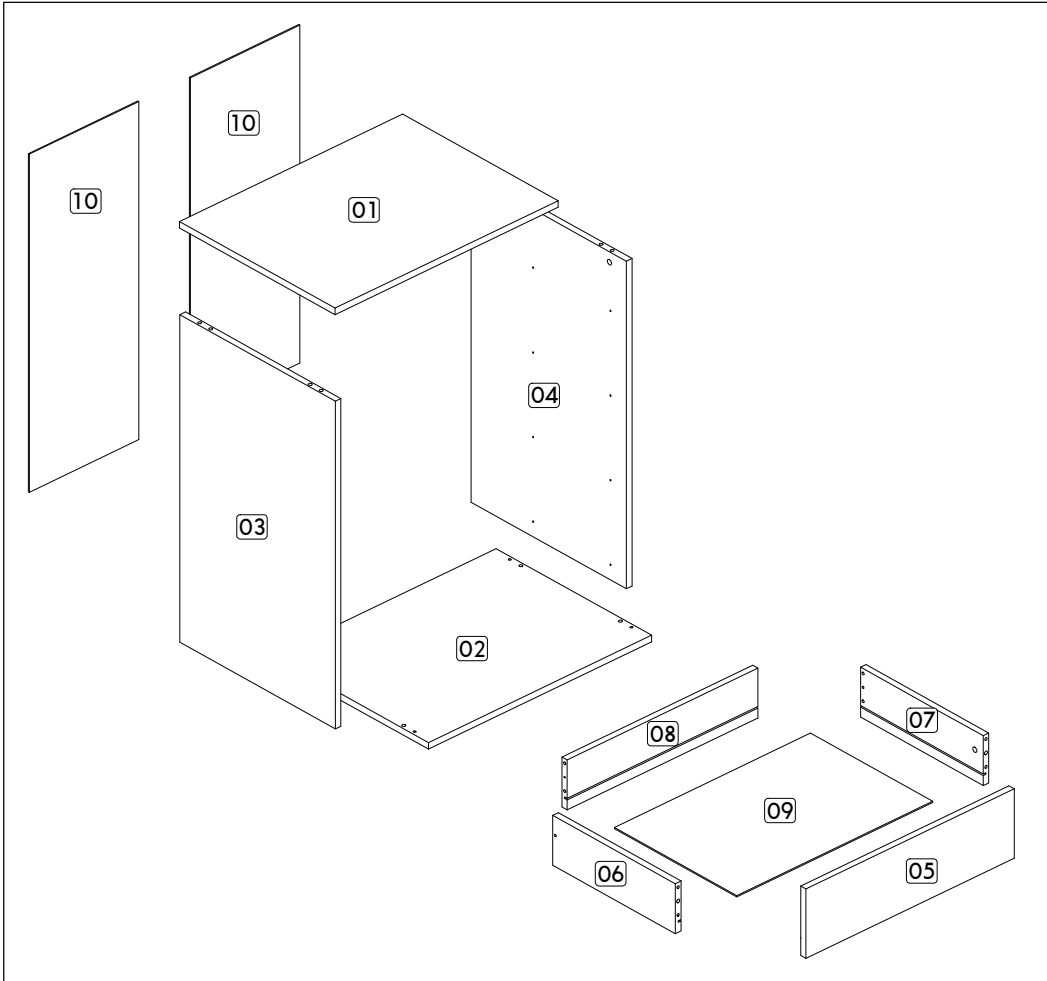

Nº	DESCRIÇÃO - DESCRIPTION - DESCRIPCIÓN	MEDIDAS - MEASURES - MEDIDAS (mm)	QTD.
01	Base superior - Top base - Base superior	600 x 450 x 15	01
02	Base inferior - Bottom base - Base inferior	600 x 450 x 15	01
03	Lateral esquerda - Left side - Lateral izquierda	755 x 450 x 15	01
04	Lateral direita - Right side - Lateral derecha	755 x 450 x 15	01
05	Frente de gaveta - Drawer front - Frente del cajón	560 x 160 x 15	04
06	Lateral esquerda de gaveta - Left side of drawer - Lateral izquierda del cajón	355 x 115 x 15	04
07	Lateral direita de gaveta - Right side of drawer - Lateral derecha del cajón	355 x 115 x 15	04
08	Traseiro de gaveta - Rear of drawer - Trasero del cajón	513 x 115 x 15	04
09	Fundo de gaveta - Bottom of drawer - Fondo del cajón	527 x 354 x 03	04
10	Costa - Back - Fondo	779 x 293 x 03	02

PRÉ-MONTAGEM/ PRE-ASSEMBLE/ PRE ARMADO

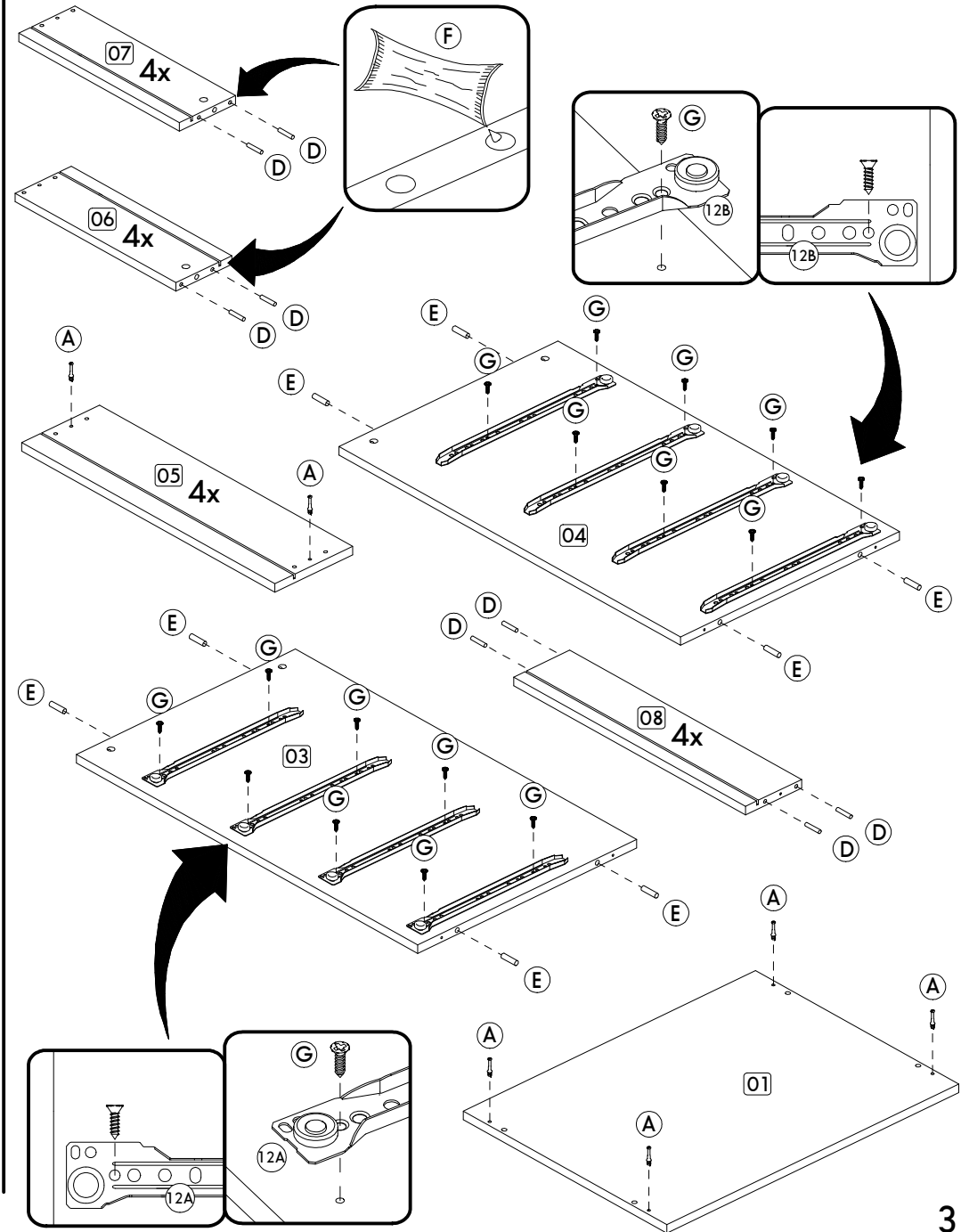

Passo/ Step/ Paso 01

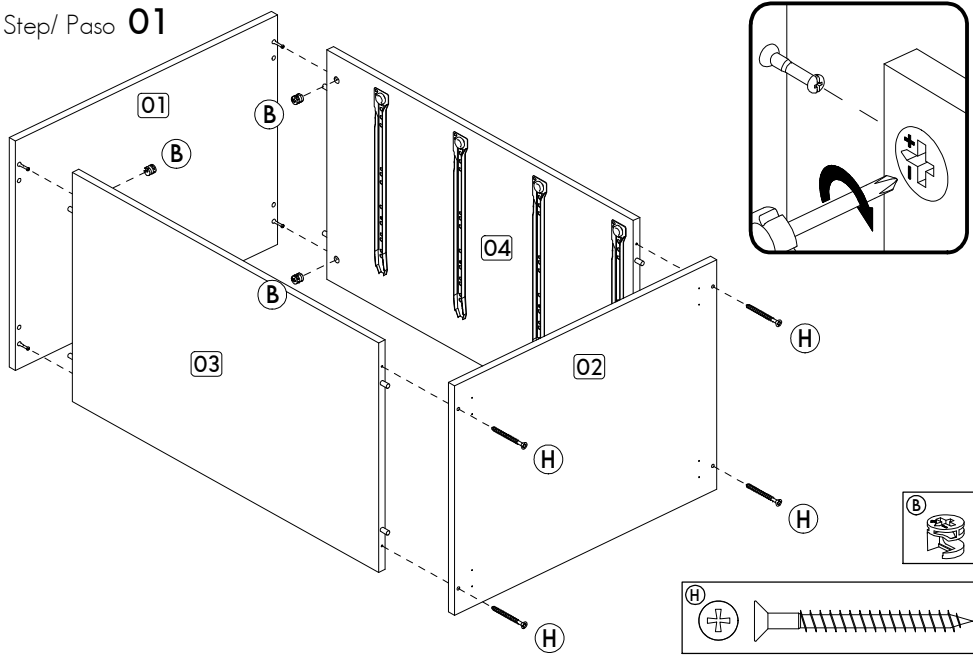

Passo/ Step/ Paso 02

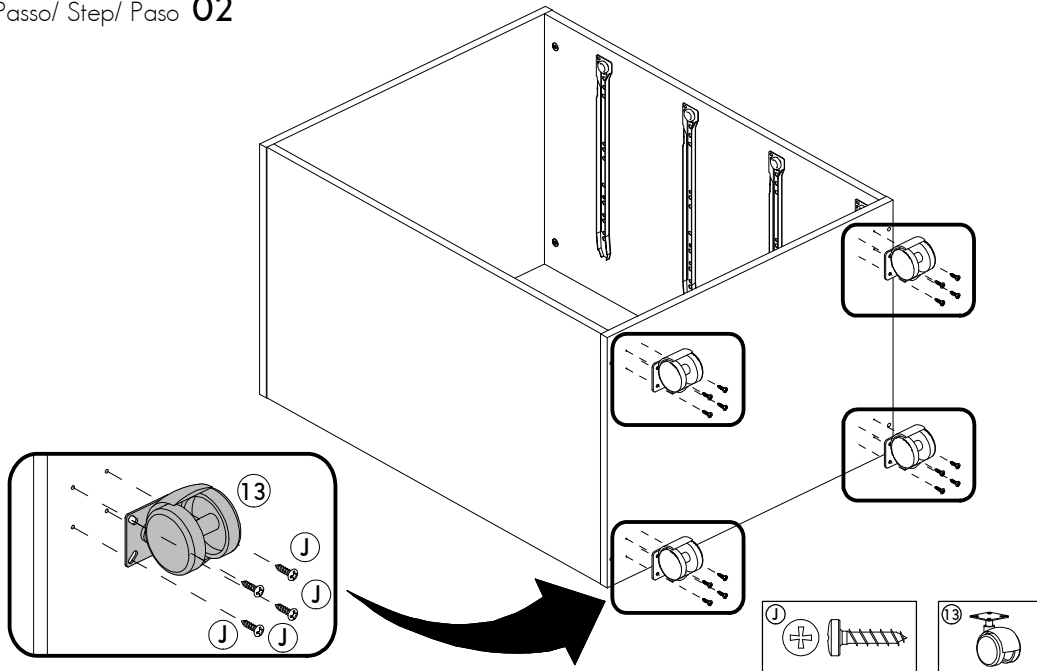

Passo/ Step/ Paso 03

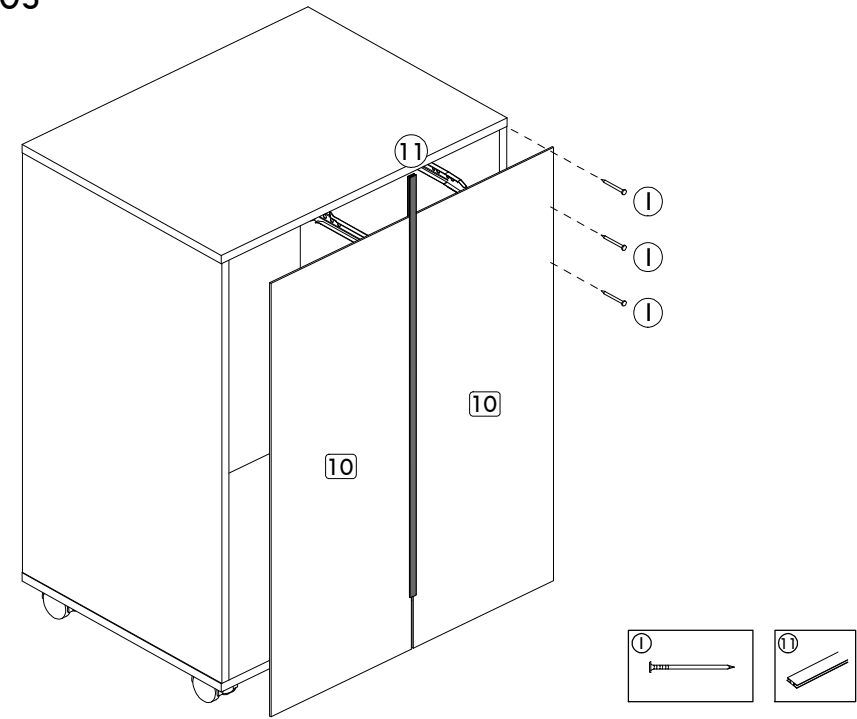

Passo/ Step/ Paso 04

