

# ARMÁRIO ORGANIZADOR FIGUEIRA

Organizer Cabinet **Figueira**  
Armario Organizador **Figueira**

Código **3368** | Revisão 04

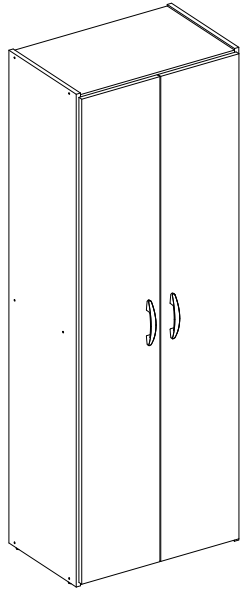

**PESO MÁXIMO SUPORTADO PELAS PEÇAS, SENDO ESTE DISTRIBUÍDO UNIFORMEMENTE.**

Maximum weight supported by parts, being this evenly distributed.  
Peso máximo soportado por las partes, siendo esta distribuido uniformemente.

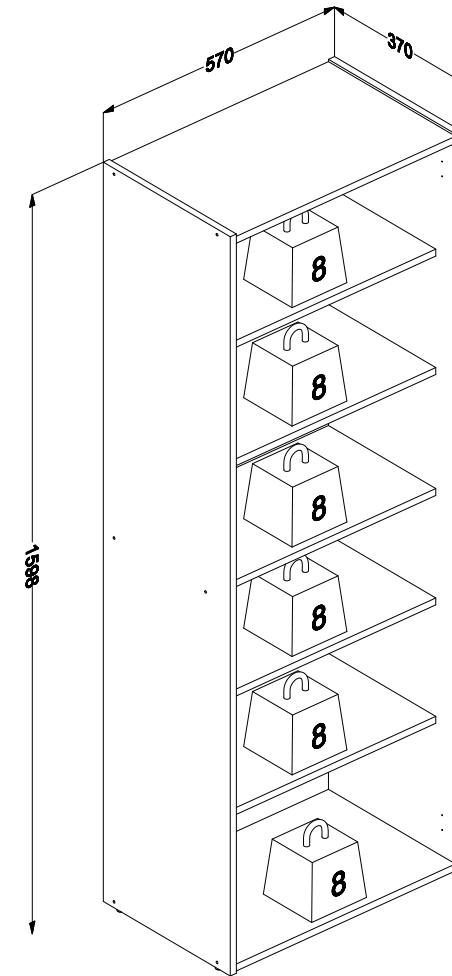

**Você vai precisar de/ You will need / Usted necesitará**

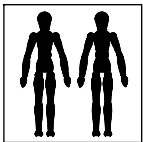

**2 Pessoas**  
2 people  
2 personas

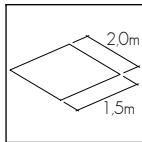

**Espaço recomendado para montagem**  
Recommended space for assemble  
Espacio recomendado para el armado

**Ferramentas não inclusas**  
Tools not included / Herramientas no incluidas

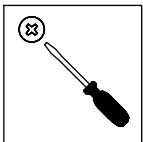

**Chave Philips**  
Screwdriver  
Destornillador cruz

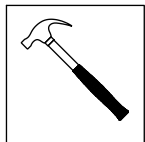

**Martelo**  
Hammer  
Martillo







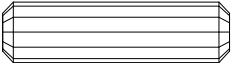
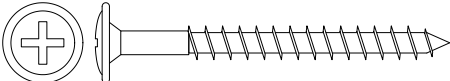
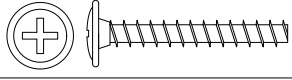
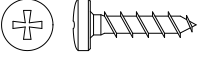

\* **PESO EM KG/Weight in Kg/ Peso en Kg**  
**DIMENSÕES EM MM/Dimensions in mm/ Dimensiones en mm**

**IDENTIFICAÇÃO DOS ACESSÓRIOS / IDENTIFICATION OF ACCESSORIES/ IDENTIFICACIÓN DE ACCESORIOS**

**NOTAS:** A separação dos acessórios antes de iniciar a montagem facilitará a mesma. Os parafusos e cavilhas estão na escala real. Em caso de dúvida na identificação, coloque o acessório sobre a imagem.

**NOTES:** The separation of the accessories before you start the assembly will facilitate the same. The screws and dowels are in real scale. In case of doubts about the identification, place the accessory on the image.

**NOTAS:** La separación de los accesorios antes de comenzar el armado facilitará el mismo. Los tornillos y taquetes son en escala real. En caso de dudas sobre la identificación, coloque el accesorio en la imagen.

A		<b>Cavilha</b> Wooden Dowel Pin	8x30 mm	12
B		<b>Parafuso flangeado</b> Flanged head screw Tornillo de cabeza flangeada	4,5x45 mm	12
C		<b>Parafuso flangeado</b> Flanged head screw Tornillo de cabeza flangeada	3,5x25 mm	04
D		<b>Parafuso panela</b> Pan head screw Tornillo de pan	3,5x14 mm	24
E		<b>Puxador</b> Handle Tirador	96 mm	02
F		<b>Dobradiça curva</b> Metal hinge curve Esquina de bisagra metálica	26mm	06
G		<b>Calço dobradiça</b> Hinge shim Bisagra de calce	-	06
H		<b>Prego</b> Nail Clavo	10 x10	45
I		<b>Sapata</b> Small Plastic Foot Pie Plástico	14 mm	04
J		<b>Suporte prateleira</b> Shelf bracket Soporte de repisa	8x7 mm	16
06		<b>Perfil H</b> Profile Perfil H	1560 mm	01

**IDENTIFICAÇÃO DAS PEÇAS/ PARTS IDENTIFICATION/ IDENTIFICACIÓN DE LAS PIEZAS**

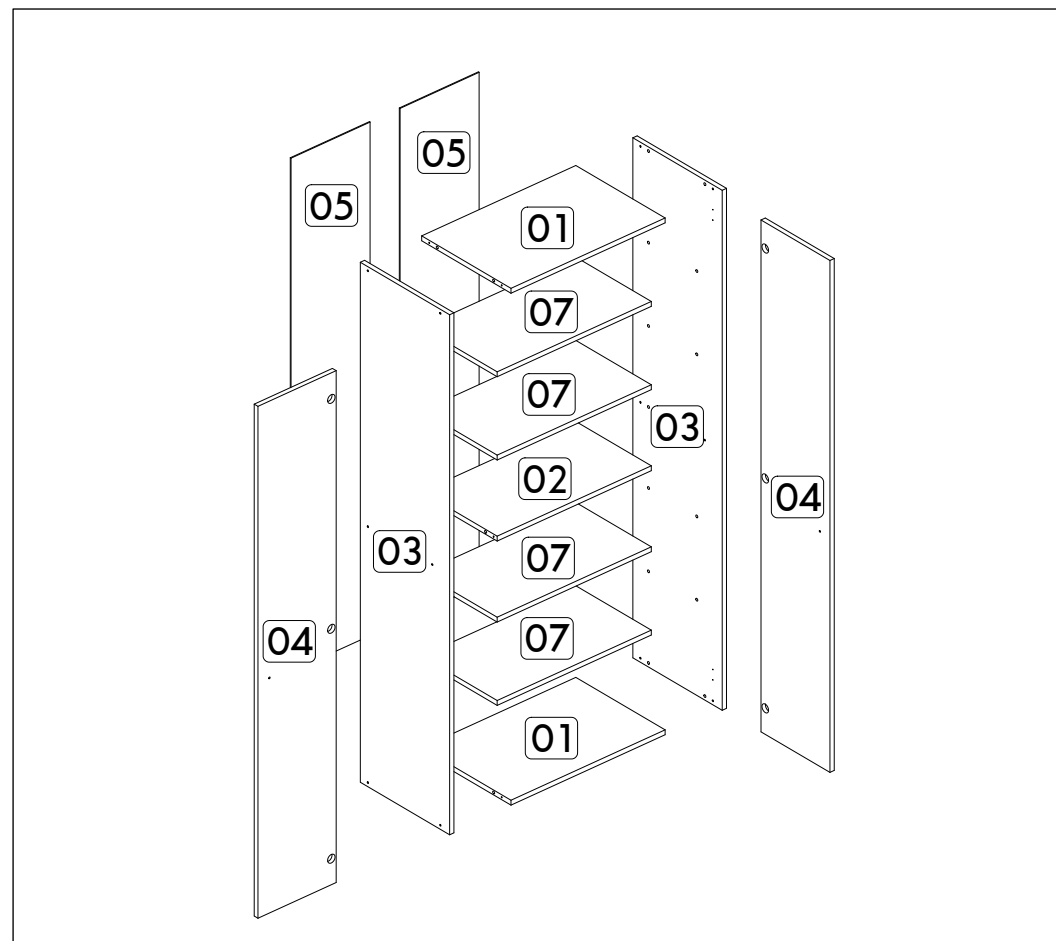

Nº	DESCRIÇÃO - DESCRIPTION - DESCRIPCIÓN	MEDIDAS-MEASURES - MEDIDAS (mm)	QTD.
01	<b>Base</b> - Base - Base	540 x 355 x 15	02
02	<b>Prateleira fixa</b> - Fixed shelf - Repisa fija	540 x 300 x 15	01
03	<b>Lateral direita/esquerda</b> - Right and left side - Lateral derecha/izquierda	1598 x 355 x 15	02
04	<b>Porta</b> - Door - Puerta	1573 x 274 x 15	02
05	<b>Costa</b> - Back - Fondo	1578 x 277 x 03	02
07	<b>Prateleira móvel</b> - Mobile shelf - Repisa móvil	540 x 300 x 15	04

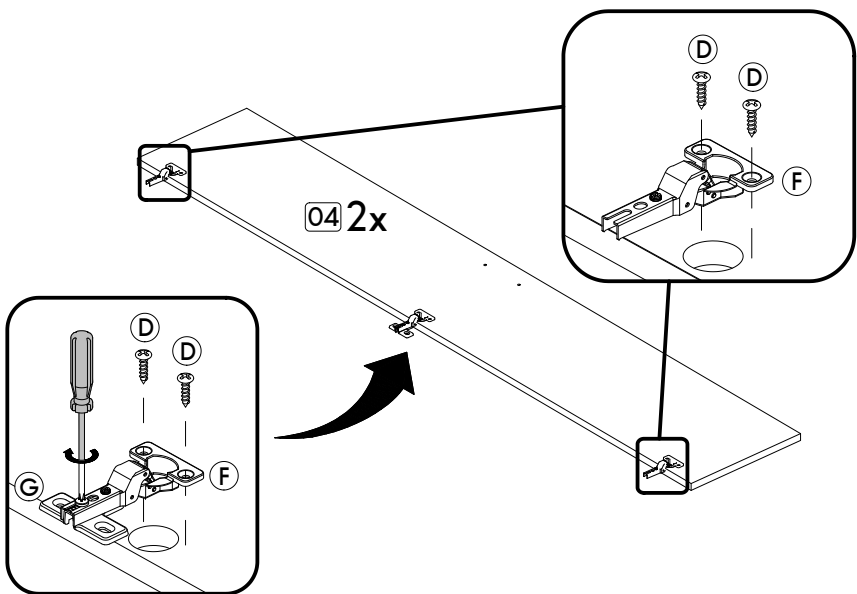
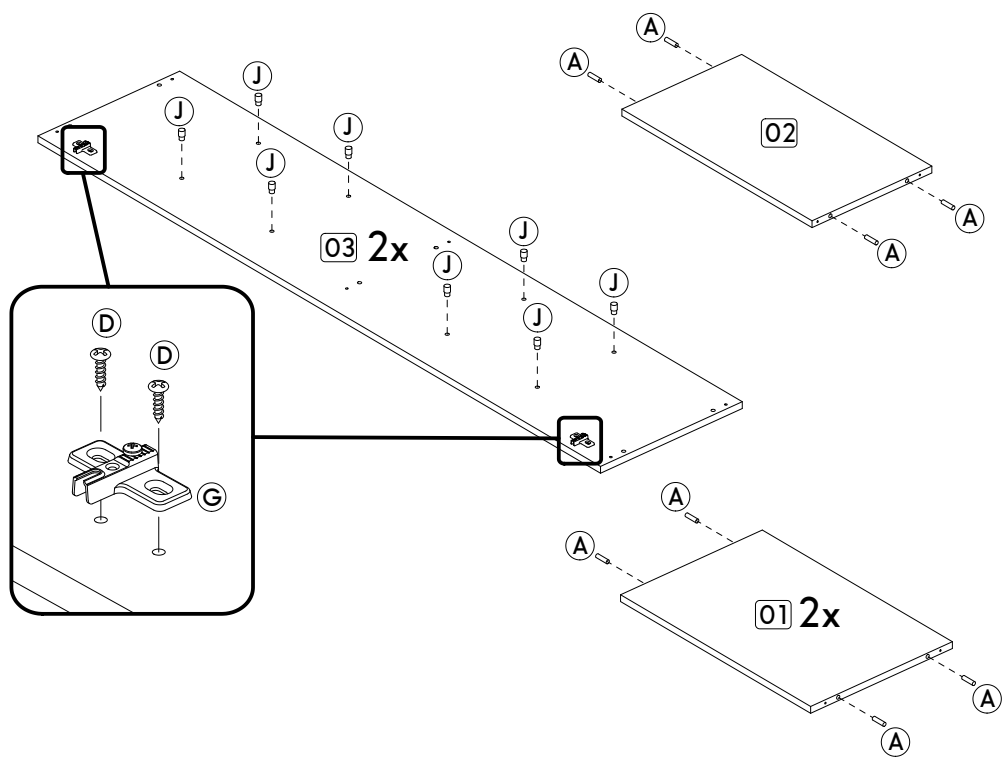

Passo/ Step/ Paso 01

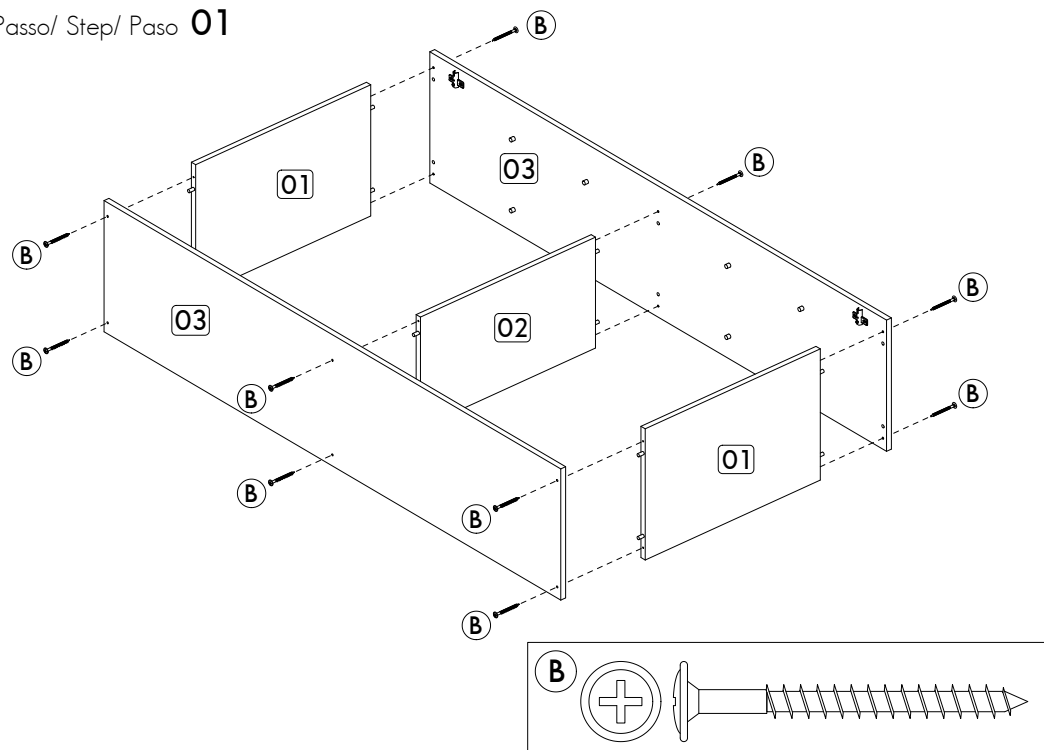

Passo/ Step/ Paso 02

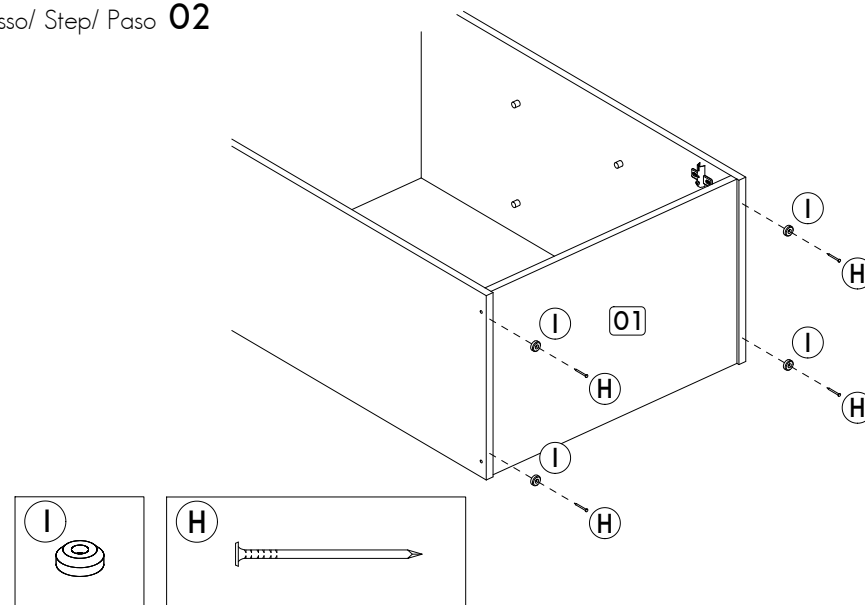

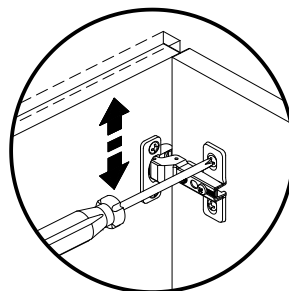
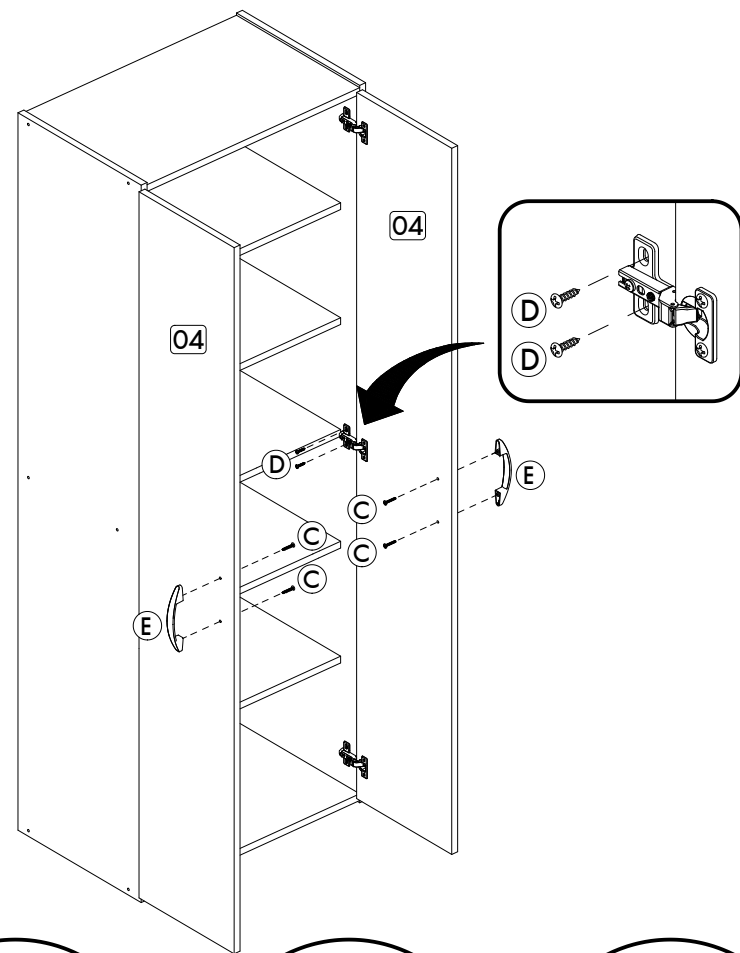
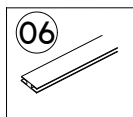
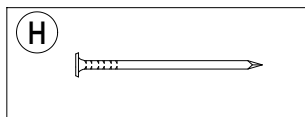
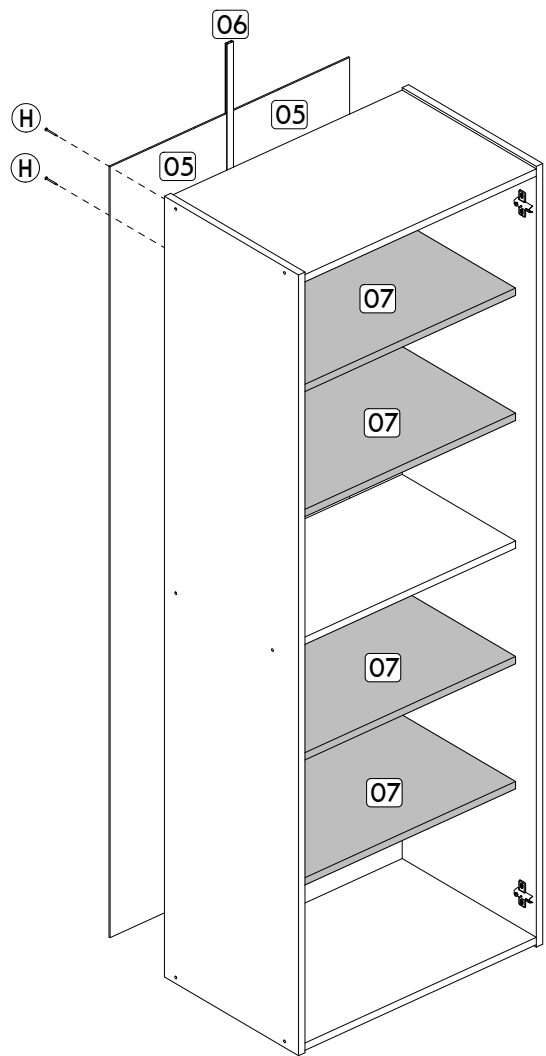

Regulagem Vertical  
Ajuste Vertical  
Vertical Adjustment

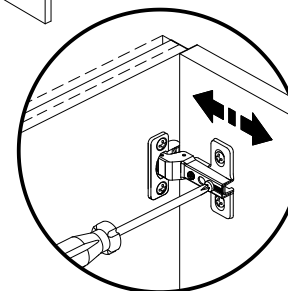

Regulagem Profundidade  
Ajuste Profundidad  
Depth Adjustment

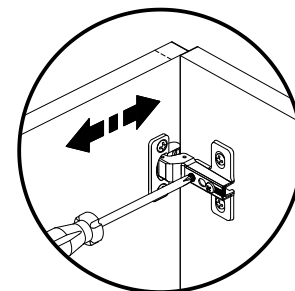

Regulagem Horizontal  
Ajuste Horizontal  
Horizontal Adjustment

