

MANUAL DE MONTAGEM

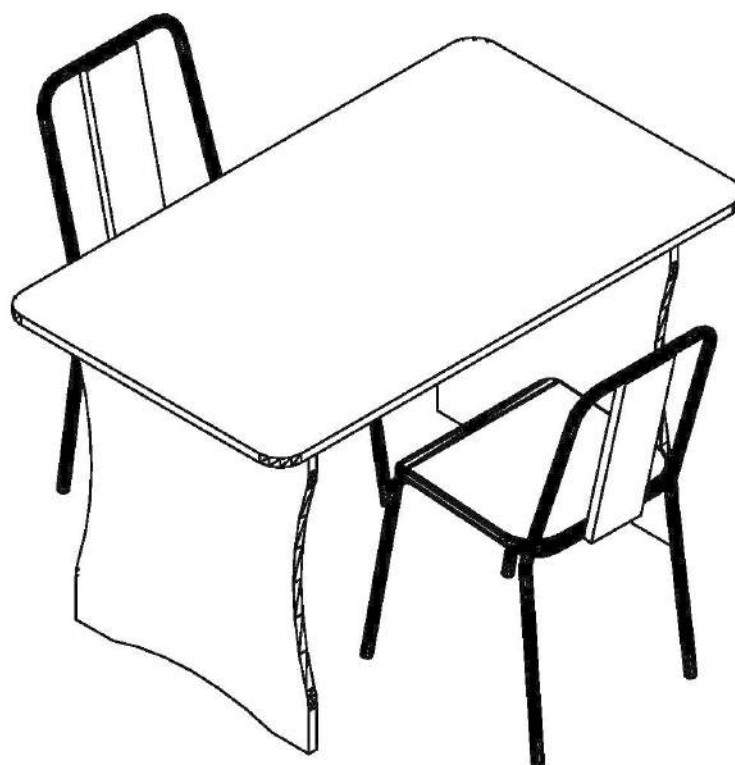





Parabéns, você acaba de adquirir um produto Kappesberg!







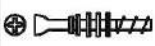

A Kappesberg é uma marca que cresceu e se desenvolveu com a população brasileira e de todos os países para onde exporta, e ao longo destes anos participa do seu dia-a-dia. É por isso que o design hoje é parte da sua vida, a qualidade de cada móvel é um compromisso diário e a inovação vem para oferecer ao cliente a confiança nessa grande parceria.



**Garantia de 06 (seis) meses,
por defeito de fabricação.**

Lista de peças						
Código de assistência	Descrição	Quant.	Compr. (mm)	Larg. (mm)	Espes. (mm)	Caixa/ volume
01	Tampo	1	906	536	15	A
02	Encosto da cadeira	4	305	96	15	A
03	Pé	2	536	446	15	A
04	Reforço	1	677	224	15	A

Ferragem			
	Código de assistência	Descrição	Quant.
A	9968	 Parafuso chato 5,0x25 zincado branco	12
B	4214	 Parafuso chato 3,5x14 cabeça rebaixada	12
C	149	 Pregos 13 x 15	4
D	1802	 Cavilha 6x30mm	4
E	30945	 Minifix (parafuso)	4
F	30950	 Minifix (tambor)	4
G	2347	 Tampa para minifix Branco	4

H	8578	 "L" de sassaç	6
I	16686	 Pino 3/16 para encaixe cadeira	4
J	2086	 Ponteira interna 5/8 reta preta	8
K	1901	 Sapata desalizador preta	4
L	31377	 Cadeira infantil	2
M	31630	 Almofada	2
N	58	 Etiqueta marca "Kappesberg"	1
O	41	 Cola branca em bisnaga (10g)	1



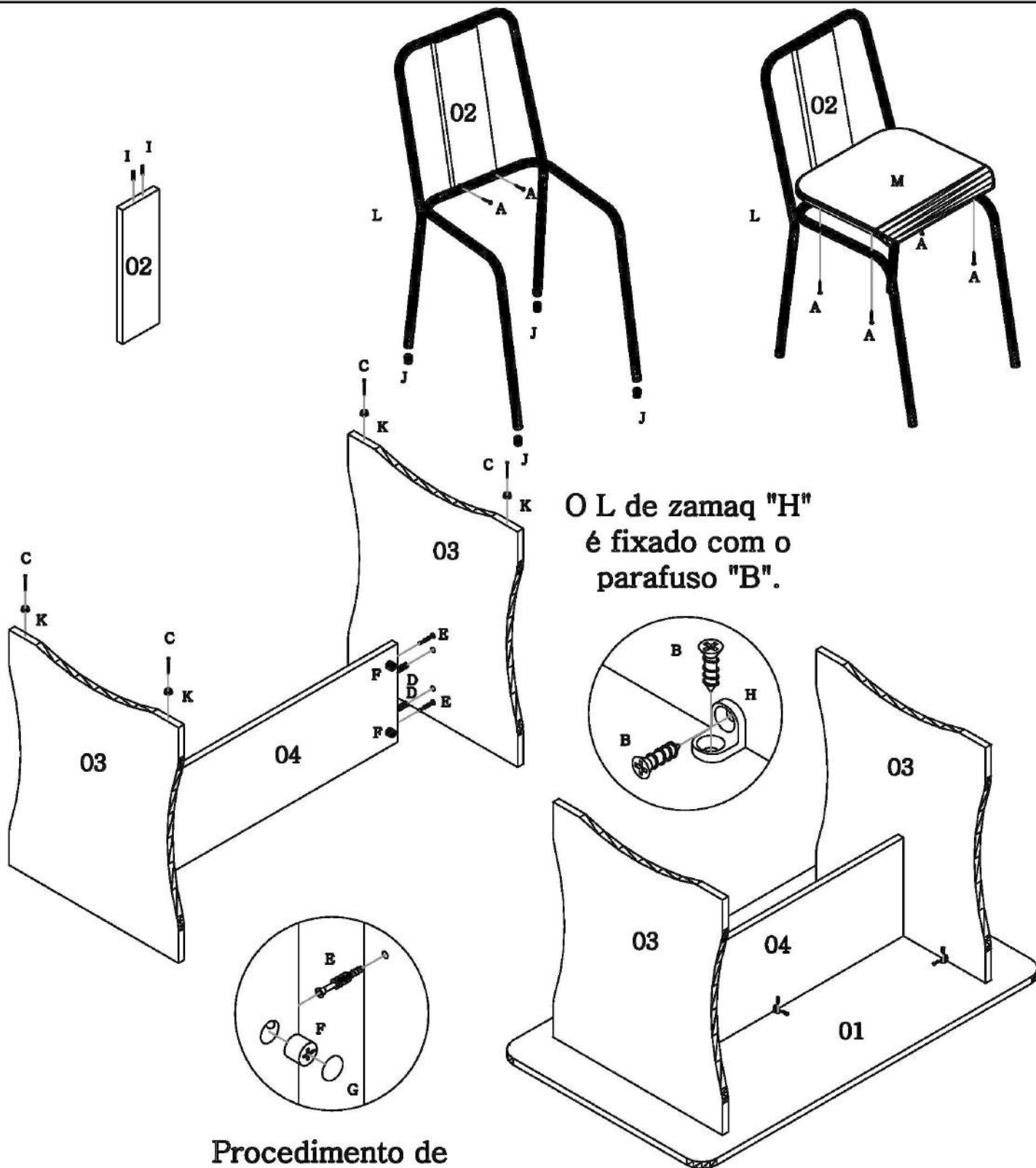

O L de zamac "H"
é fixado com o
parafuso "B".

Procedimento de
fixação do minifix.

Fixe os pés e o reforço no
tampo utilizando o L de zamac
"H", observando as medidas ao
lado.

