

# ME-4110

## Instruções de Montagem Instrucciones de Montaje

### Notas especiais:









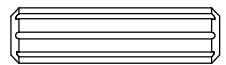
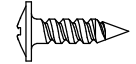

- 01** - Examine completamente todas as peças do móvel antes de iniciar o trabalho.  
**02** - Recomenda-se montar o móvel conforme este Manual de Montagem.  
**03** - É de responsabilidade do montador seguir as instruções do Manual de Montagem, que são fundamentais para garantir a estrutura do móvel.  
**04** - Para limpeza utilizar somente pano úmido e sabão neutro.

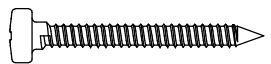
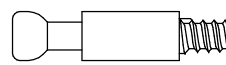
### Notas especiales:

- 01** - Examine completamente todas las piezas del mueble antes de iniciar el trabajo.  
**02** - Se recomienda montar el mueble conforme el Manual de Esamblaje.  
**03** - Es de responsabilidad del montador seguir las instrucciones del Manual de Esamblaje, que son fundamentales para garantizar la estructura del mueble.  
**04** - Para limpieza solamente usar trapo húmedo y jabón neutro.

### Lista de peças / Lista de piezas

CÓD	DESCRIÇÃO	QTD	M. PRIMA	DIMENSÕES
01	Tampo	1	MDP 15mm	300 x 598 x 15mm
02	Base	2	MDP 15mm	300 x 568 x 15mm
03	Lateral Direita	1	MDP 15mm	1694 x 300 x 15mm
04	Lateral Esquerda	1	MDP 15mm	1694 x 300 x 15mm
05	Prateleira Móvel	3	MDP 15mm	255 x 568 x 15mm
06	Travessa	1	MDP 15mm	599 x 45 x 15mm
07	Travessa Direita	1	MDP 15mm	1710 x 45 x 15mm
08	Travessa Esquerda	1	MDP 15mm	1710 x 45 x 15mm
09	Rodapé	1	MDP 15mm	70 x 568 x 15mm
10	Costa	2	Chapa Dura 3mm	1634 x 294 x 3mm
11	Porta	2	MDP 15mm	620 x 250 x 15mm

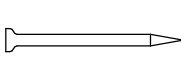
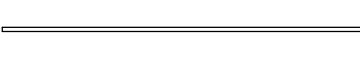
REF	DESCRIÇÃO	QTD
<b>A</b>	 Cavilha 8 x 30mm	<b>04</b>
<b>B</b>	 Parafuso 3,5 x 14mm CF	<b>20</b>
<b>C</b>	 Parafuso 3,5 x 16 CC	<b>16</b>
<b>D</b>	 Parafuso 3,5 x 30CP	<b>02</b>
<b>E</b>	 Parafuso minifix	<b>12</b>
<b>F</b>	 Tambor minifix	<b>16</b>
<b>G</b>	 Minifix haste dupla	<b>02</b>
<b>H</b>	 Suporte angular	<b>10</b>
<b>I</b>	 Puxador Ponto	<b>02</b>
<b>J</b>	 Adesivo Tapafuro	<b>04</b>
<b>K</b>	 Sapata	<b>04</b>
<b>L</b>	 Dobradiça	<b>04</b>
<b>M</b>	 Suporte de prateleira	<b>12</b>
<b>N</b>	 Prego 10 x 10CC	<b>45</b>
<b>O</b>	 Perfil	<b>01</b>

### Ferramentas | Herramientas

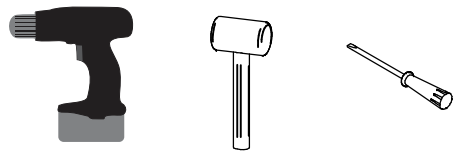

30 min.

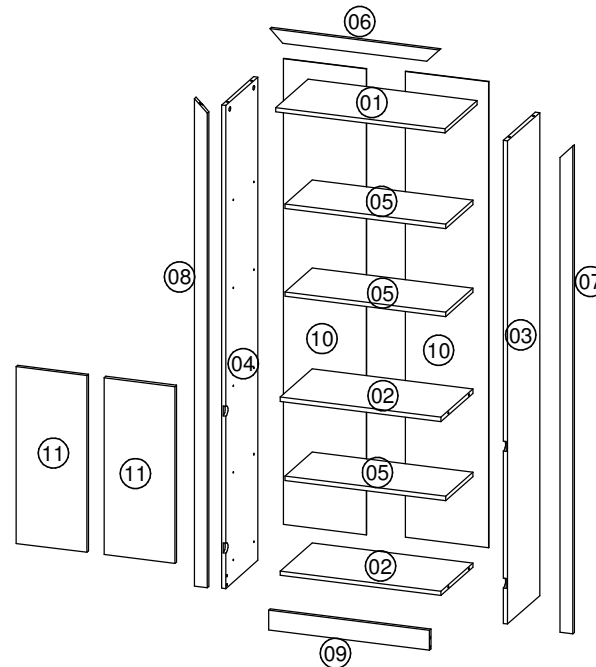

Data: 27/09/2013  
Revisão: 00

