

# Ref. 879

## Ropero 6 Puertas | 6-Door Wardrobe | Roupeiro 6 Portas

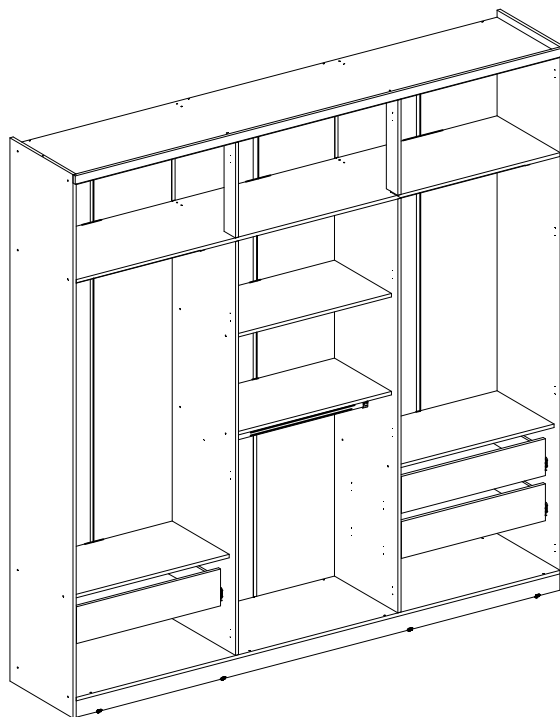

### ACCESORIOS / HARDWARE / ACESSÓRIOS

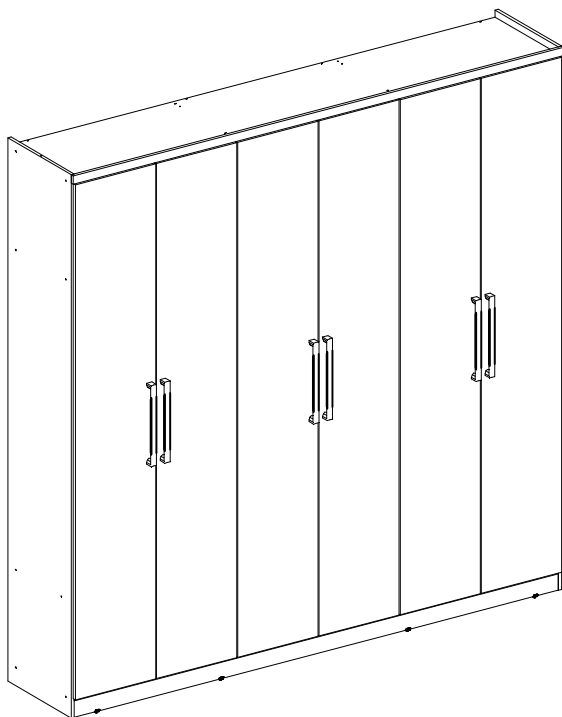
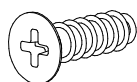

A Ø4 x 14 | 192 un.

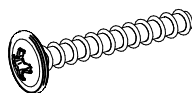

B Ø3,5 x 25 | 12 un.

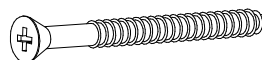

C Ø4,5 x 50 | 48 un.



D | 160 un.



E | 24 un.



F | 20 un.

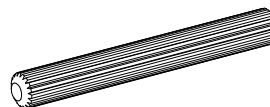

G | 2 un.



H | 1 un.

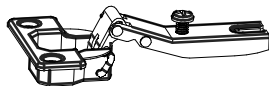

I | 24 un.

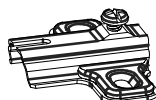

J | 24 un.

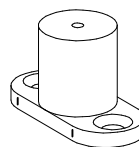

K | 12 un.

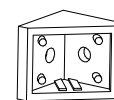

L | 18 un.

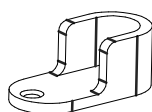

M | 6 un.



N | 8 un.



O | 40 un.



P | 18 un.

FERRAMIENTAS  
HARDWARE  
FERRAMENTAS

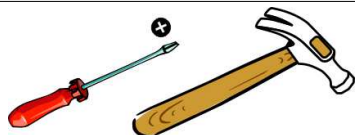

PERSONAS NECESARIAS PARA EL MONTAJE  
PEOPLE REQUIRED FOR ASSEMBLY  
PESSOAS NECESSÁRIAS PARA A MONTAGEM



### Consejos de Conservación

- No debe utilizarse en la limpieza, abrasivos como lana de acero, alcohol, vinagre, limón, o productos corrosivos que puedan rayar o quitar la película protectora en los muebles.
- Cuando la limpieza de muebles en general, napa y formica, deben utilizarse un paño ligeramente humedecido y jabón suave.
- Para mover el móvil, es importante que este se eleve desde el suelo, debido a que el arrastre puede causar daño estructural.
- No deje a su móvil en exposición a la intemperie.

### Conservation Tips

- Do not use abrasive products to clean such as steel wool, alcohol, vinegar, lemon, scouring powder, or corrosive products which can scratch or peel off the protective film of the furniture.
- The best way to clean your furniture is to use a slightly moistened cloth with a mild soap.
- To move the furniture assembled, it is important that it is lifted off the ground, because the drag it can cause structural damage.
- Do not leave your furniture in weather exposure.

### Dicas de Conservação

- Não utilizar na limpeza produtos abrasivos tais como: palha de aço, álcool, vinagre, limão, saponáceo, ou produtos corrosivos que possam riscar ou descolar a película protetora dos móveis.
- Na limpeza de móveis em geral, napa e fórmicas, deve ser utilizado um pano levemente umedecido e sabão neutro.
- Para a movimentação do móvel, é importante que este seja levantado do chão, pois ao arrastá-lo pode causar avarias estruturais.
- Não deixe o móvel em exposição a intempéries.

### Certificado de Garantia

A garantia do produto segue normas legais e contratuais e inicia-se a contagem a partir da emissão da nota fiscal de compra. A garantia cobre somente defeitos de fabricação. Deve-se verificar se a montagem foi feita corretamente, pois este é o momento ideal para detectar qualquer problema de fabricação.

#### Peso por estante

Por favor, preste atención a los pesos máximos admitidos por cada compartimento del producto. Tenga cuidado de no exceder estos pesos, con el fin de garantizar la calidad y durabilidad del producto.

Es importante recordar que los pesos muestran en caso de ser distribuida en toda el área de la plataforma.

#### Weight per shelf

Please pay attention to the maximum weights supported by each compartment product. Be careful not to exceed these weights, in order to ensure the quality and durability of the product. It is important to remember also that the weights shown should be distributed throughout the area of the shelf.

#### Peso por Prateleira

Ao lado são demonstrados os pesos máximos suportados por cada compartimento do produto. Cuide para não exceder esses pesos, afim de garantir a qualidade e a durabilidade do mesmo. É importante lembrar também, que os pesos mostrados devem ser DISTRIBUÍDOS ao longo de toda a área da peça.

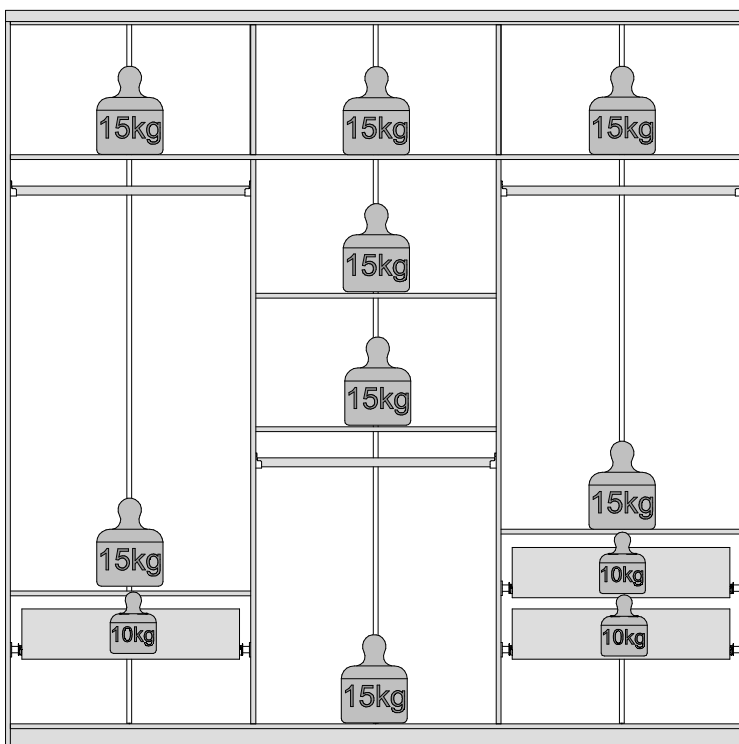

LISTA DE PIEZAS / LIST OF PARTS / RELAÇÃO DE PEÇAS

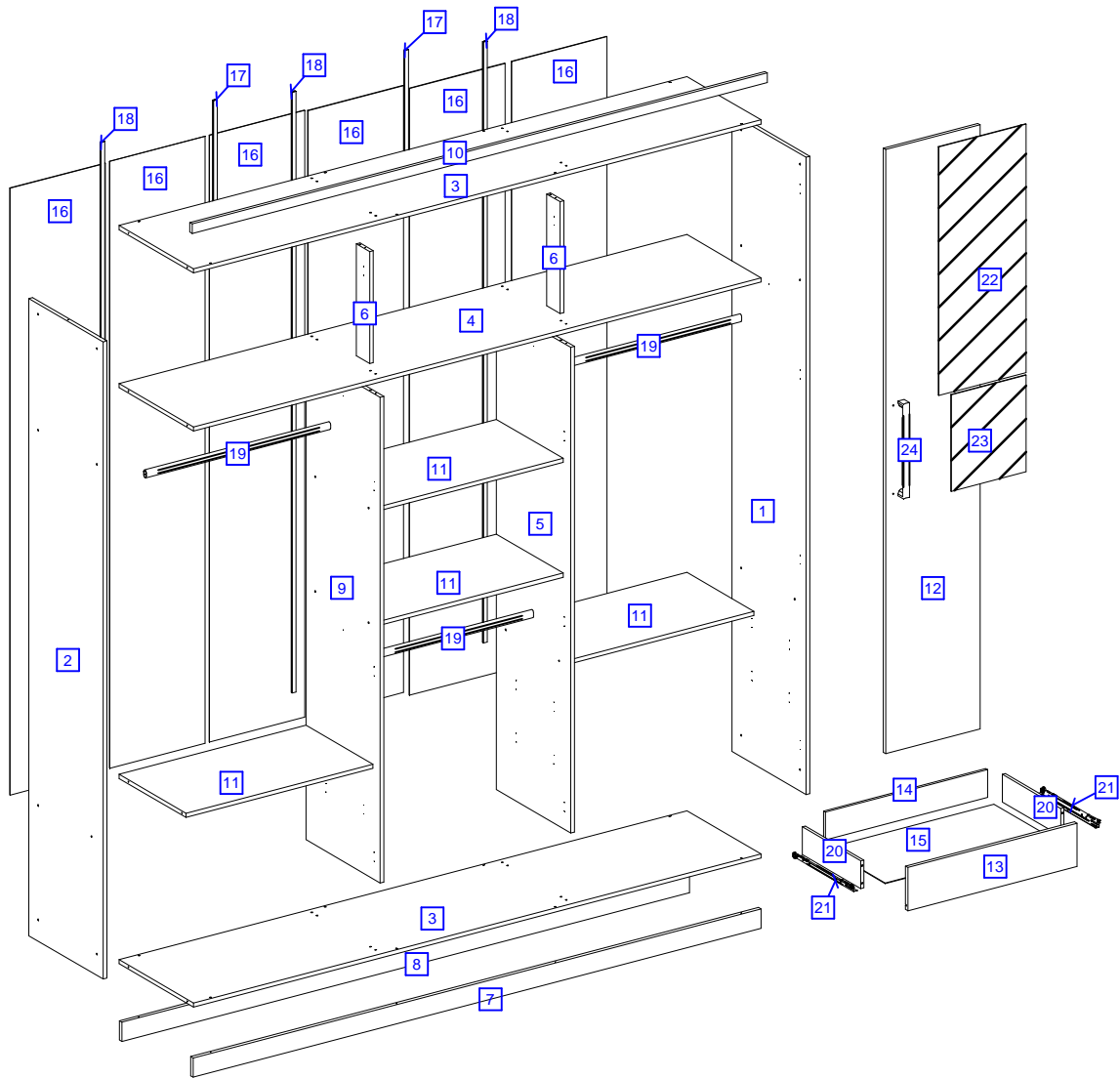

#	Cantidad Cantity Quant	Piezas	Piecés	Peças	Dimension Dimensões Dimensões	Códigos para repuestos / Codes for replacement / Códigos para reposição			
						Anis	Ébano	Atacama	Gamuza Chamois Camurça
1	1	Lateral Derecha	Right Side	Lateral Direita	2310 x 444 x 15	087916258	087916223	-	-
2	1	Lateral Izquierda	Left Side	Lateral Esquerda	2310 x 444 x 15	087916259	087916225	-	-
3	2	Base Tapa	Base-Top	Base-Chapéu	2280 x 444 x 15	087916285	087916279	-	-
4	1	Tapa Intermediaria	Intermediate Top	Chapéu Intermediário	2280 x 444 x 15	087916286	087916281	-	-
5	1	División Derecha	Right Division	Divisão Direita	1760 x 444 x 15	087916282	087916276	-	-
6	2	Pilastra	Pilaster	Pilastra	405 x 80 x 15	087916283	087916277	-	-
7	1	Zócallo Frontal	Frontal Baseboard	Rodapé Dianteiro	2280 x 70 x 15	087916252	087914887	-	-
8	1	Zócallo Trasero	Back Baseboard	Rodapé Traseiro	2280 x 70 x 15	087904109			
9	1	División Izquierda	Left Division	Divisão Esquerda	1760 x 444 x 15	087916284	087916278	-	-
10	1	Marco Superior	Upper Frame	Moldura Superior	2310 x 35 x 15	087916251	087916075	-	-
11	4	Estante	Shelf	Prateleira	750 x 400 x 15	-	-	-	087914131
12	6	Puerta	Door	Porta	2190 x 378 x 15	087916275	087916268	087916267	087915723
13	3	Frente del Cajón	Front Drawer	Frente de Gaveta	679 x 157 x 15	-	-	-	087915202
14	3	Costado del Cajón	Back Drawer	Costa de Gaveta	651 x 100 x 12	-	-	-	087914116
15	3	Fondo del Cajón	Bottom Drawer	Fundo de Gaveta	675 x 355 x 2,5	-	-	-	087914149
16	6	Costado	Back Panel	Costa	2200 x 383 x 2,5	-	-	-	087915732
17	2	Perfil I Menor	Smaller "T" Profile	Perfil I Menor	403 x 15 x 6	-	-	-	000048167
18	3	Perfil I Grande	Biggest "T" Profile	Perfil I Maior	2178 x 15 x 6	-	-	-	000048158
19	3	Rolizo Percha	Hanger Rod	Cabideiro	28 x 16 x 0,45 x 740	-	-	-	000048166
20	6	Lateral del Cajón	Side Drawer	Lateral de Gaveta	350 x 100 x 12	-	-	-	087914152
21	3	Corredera Metalica	Metalic Runner	Corrediça Metálica	Compr.: 350mm	000018095			
22	4	Espejo Grande	Biggest Mirror	Espelho Maior (Opcional)	900 x 350 x 3	000048169			
23	2	Espejo Menor	Smaller Mirror	Espelho Menor (opcional)	350 x 300 x 3	000018170			
24	6	Tirador	Handle	Puxador	340mm	000048165			
25	1	Accesorios	Hardware	Acessórios	-	000048162	000048161	-	-

1

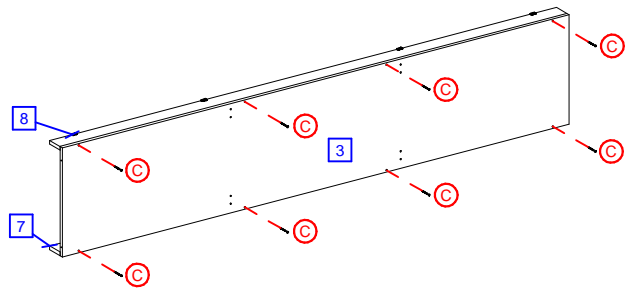

2

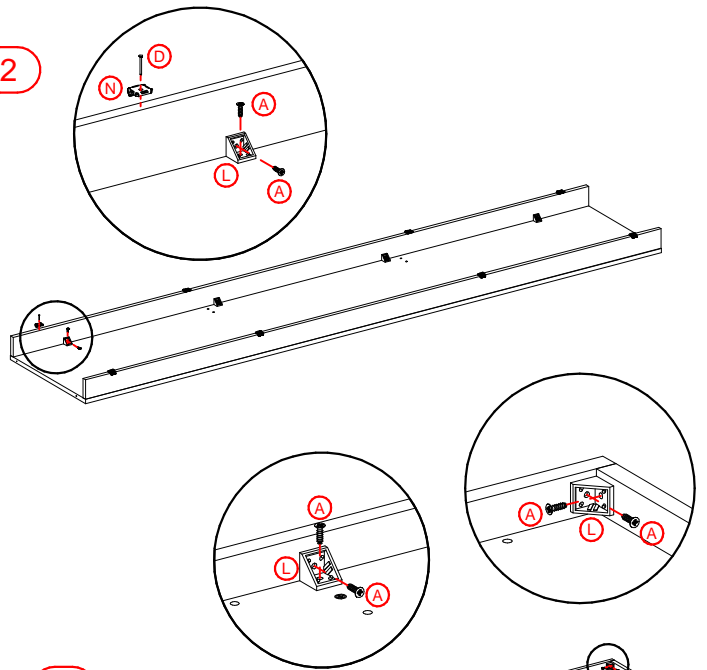

3

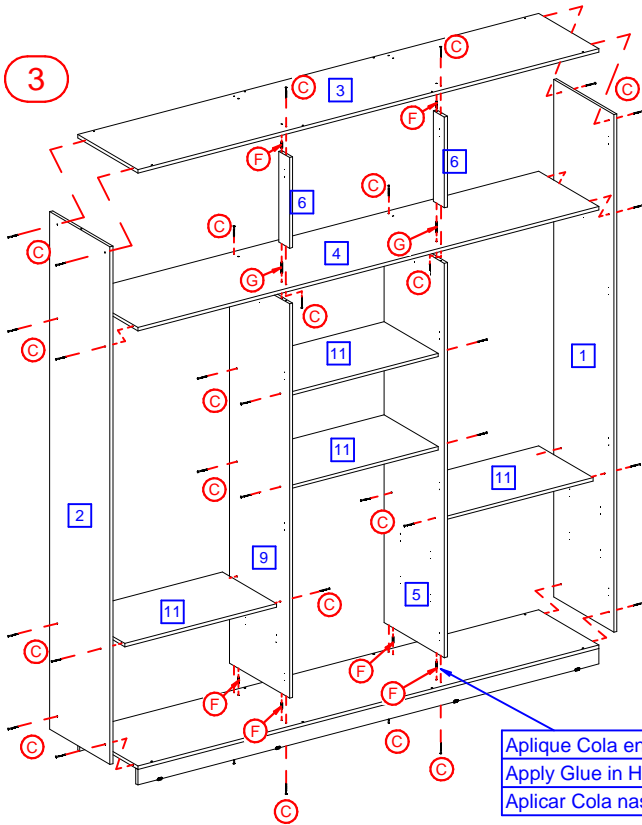

4

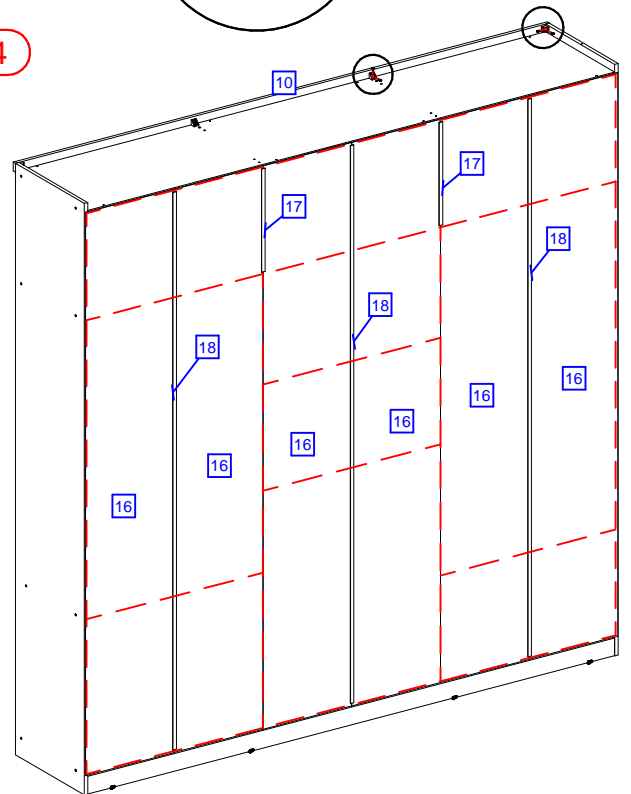

5

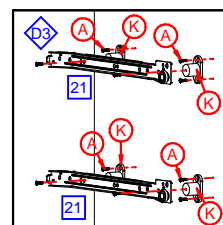
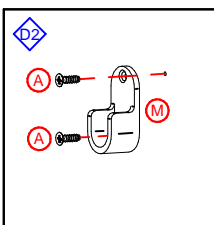
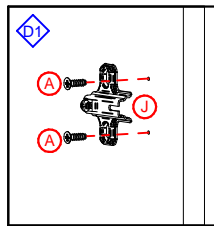
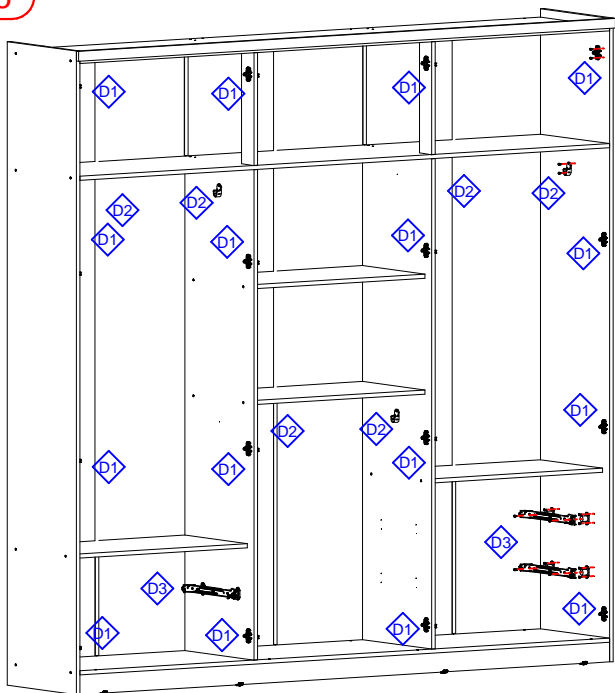

Fijar fondo con clavos cada 150mm, en la línea de puntos.

Fasten bottom drawer with nails every 150mm, where indicated by the dotted line.

Fixar fundo de gaveta com pregos, a cada 150mm, onde indicado pela linha pontilhada.

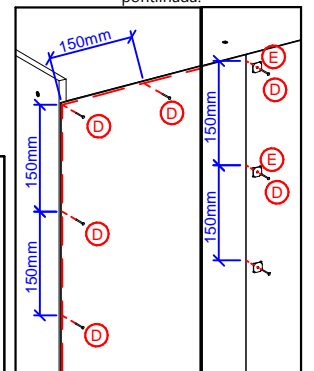

6

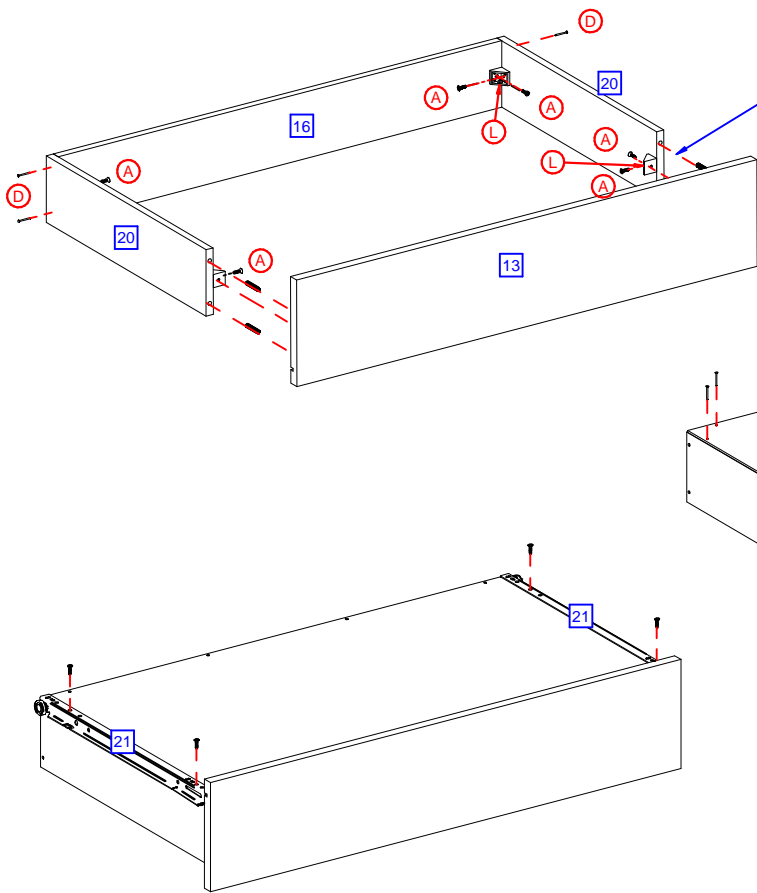

Aplique Cola en los Agujeros  
Apply Glue in Holes  
Aplicar Cola nas Furações

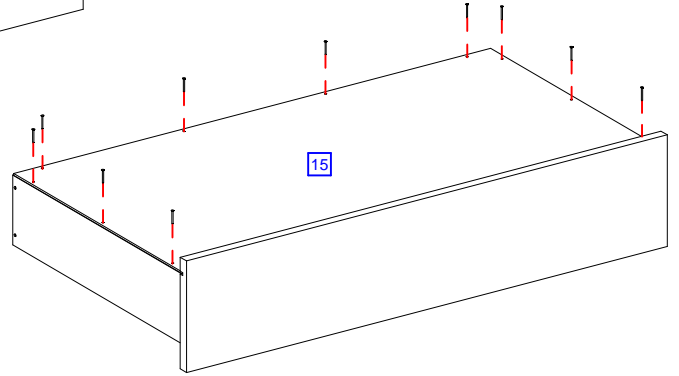

Aplique los adhesivos en los puntos de fijación aparentes.  
Fix the stickers to the drillings.  
Aplicar os adesivos nos pontos de fixação aparentes.

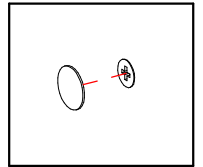

7

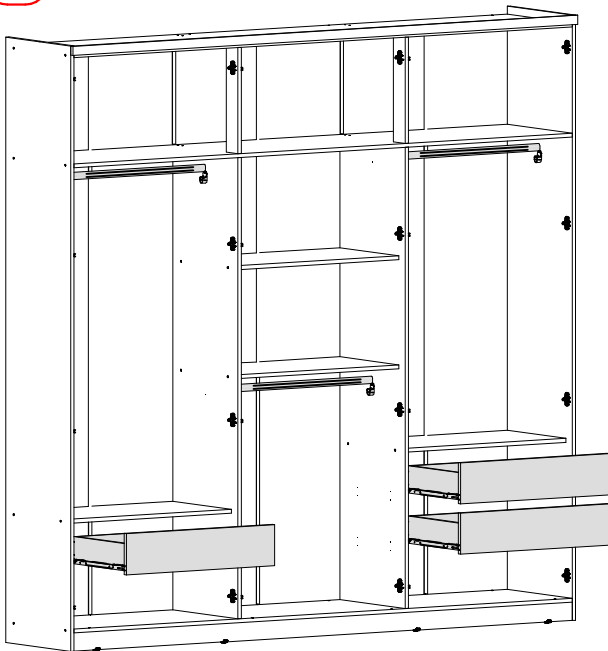

8

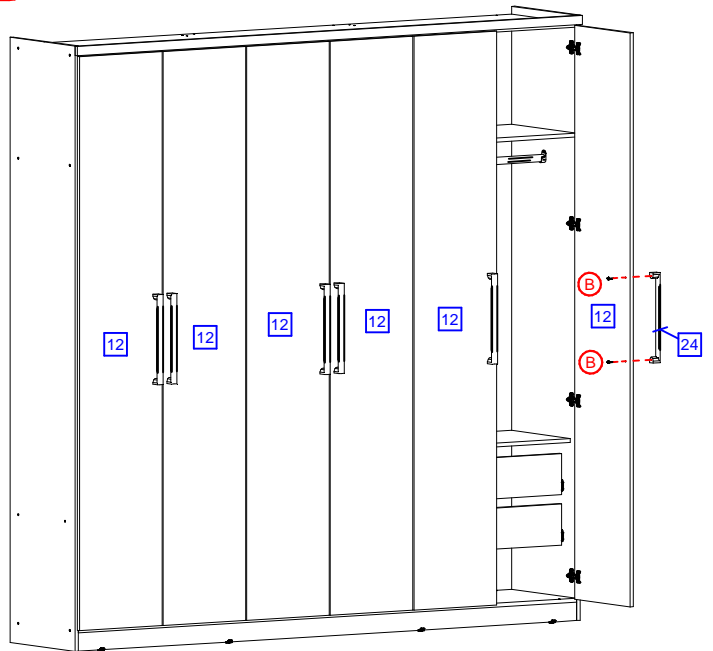

### Ajuste das Portas / Door Adjustment / Ajuste de las Puertas

Encaixe da porta  
Door setting  
Encaje de la puerta

Ajuste de Altura  
Height Adjustment  
Ajuste del alto

Ajuste Interno  
Internal Adjustment  
Ajuste Interno

Ajuste de Profundidade  
Depth Adjustment  
Ajuste de la profundidad

