

















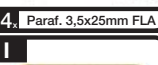















## LISTA DE PEÇAS

Item	Caixa	Qtd	Descrição	Medidas (mm)
01	2/3	02	Rodapé cru	1133x65x15
02	2/3	01	Rodapé frontal MDF	1163x70x15
03	1/3	01	Lateral esquerda	2000x447x15
04	1/3	01	Base	1133x447x15
05	2/3	01	Divisão	1920x447x15
06	2/3	04	Prateleira lateral	365x395x15
07	1/3	01	Lateral direita	2000x447x15
08	2/3	01	Prateleira central	753x395x15
09	1/3	01	Prateleira central maior	753x447x15
10	2/3	01	Tampo superior MDF	1163x500x15
11	1/3	02	Moldura lateral	2040x70x25
12	1/3	01	Moldura superior MDF	1163x125x25
13	1/3	04	Ripa lateral	400x54x25
14	1/3	03	Fundo	1944x384x03
15	3/3	02	Porta lateral MDF	1920x381x15
16	3/3	01	Porta central MDF	1920x381x15
17	1/3	02	Frente de gaveta	693x170x15
18	1/3 e 2/3	04	Lado de gaveta	350x122x15
19	2/3	02	Fundo de gaveta	659x346x03
20	1/3	02	Ripa de trás	648x122x15

## LISTA DE FERRAGENS

<b>A</b>  16. Paraf. 4,5x50mm FLA	<b>B</b>  12. Paraf. 4,5x50mm CHT
<b>C</b>  21. Paraf. 4,0x35mm CHT	<b>D</b>  03. Paraf. 4,0x25mm CHT
<b>E</b>  48. Paraf. 3,5x14mm FLA	<b>F</b>  50. Paraf. 3,5x12mm CHT
<b>G</b>  04. Paraf. 3,5x25mm FLA	<b>H</b>  04. Parafuso minifix
<b>I</b>  46. Cavilha 5x25mm	<b>J</b>  04. Tambor minifix
<b>K</b>  28. Porca cilíndrica	<b>L</b>  04. Cantoneira plástica 20x20
<b>M</b>  16. Fixador de fundos	<b>N</b>  06. Sapata "L" 15x30mm
<b>O</b>  02. Suporte cabideiro	<b>P</b>  04. Dobradiça 26mm colo alto
<b>S</b>  02. Corrediça metal 350mm	<b>T</b>  100. Prego 10x10
<b>W</b>  02. Puxador R62PW	<b>X</b>  18. Suporte p/ fixação vidro
<b>AA</b>  04. Tampa tambor minifix	<b>AB</b>  01. Giz de correção
<b>AE</b>  02. Vidro temperado 880x190x03	<b>AG</b>  01. Cabideiro metal 747mm
<b>AI</b>  04. Cantoneira suporte triangular	<b>AJ</b>  04. Paraf. 3,0x16mm CHT
<b>U</b>  10. Prego 12x12	<b>V</b>  01. Puxador F80VW 192mm
<b>Y</b>  13. Tapa furo 12mm	<b>Z</b>  05. Tapa furo 5mm
<b>AC</b>  01. Etiqueta adesiva	<b>AD</b>  01. Sachê de cola
<b>AH</b>  01. Perfil "I" 1930mm	

HENN

MÓVEIS  
DO SEU  
JEITO

www.henn.com.br  
henn@henn.com.br  
55 49 3674 3500  
Mondai/SC - Brasil

## INSTRUÇÃO DE MONTAGEM

## Roupeiro 3 Portas Maçã do Amor

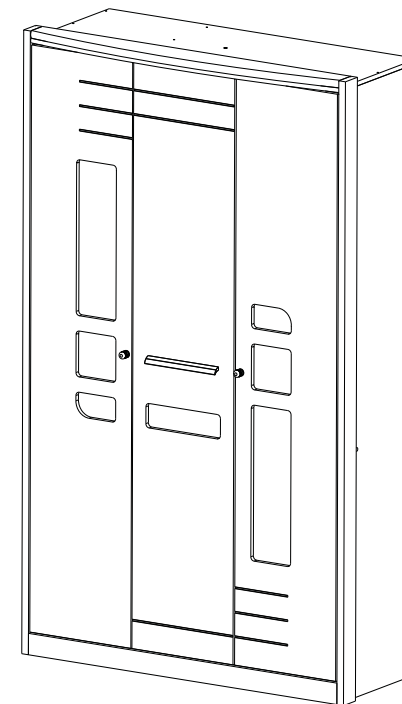

 69632-Branco

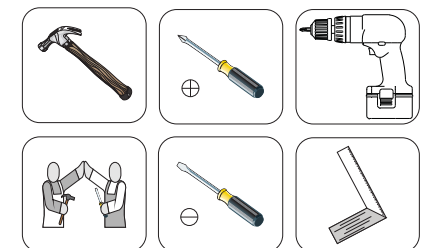
## REQUISITOS PARA MONTAGEM

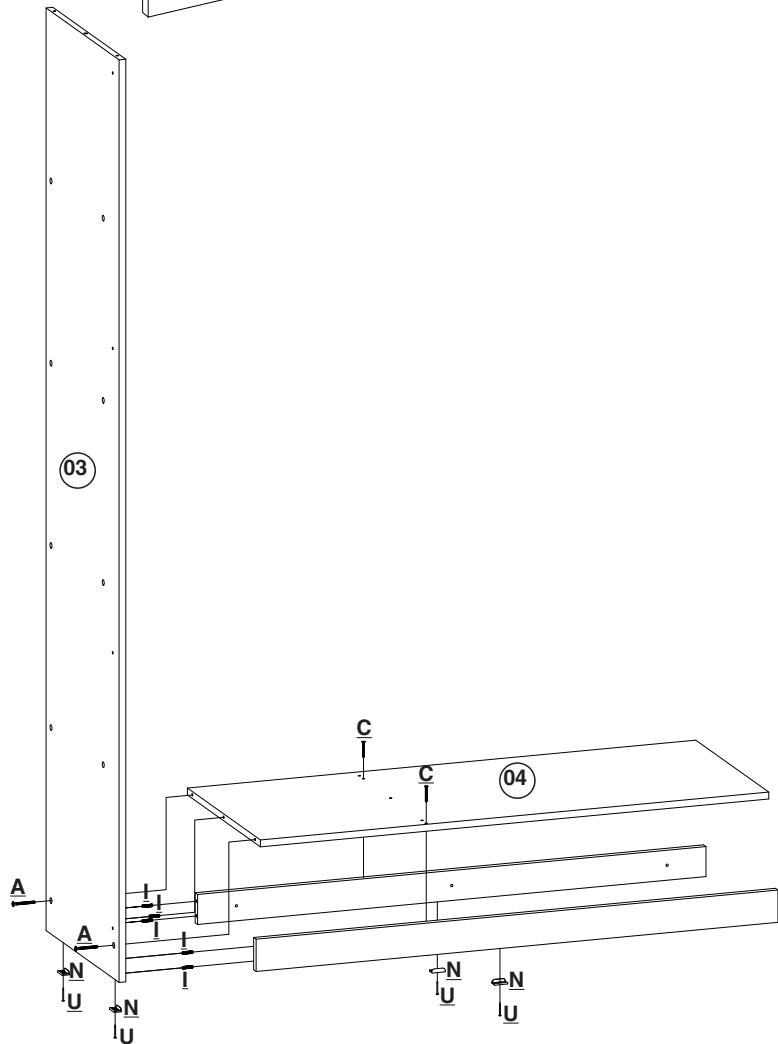
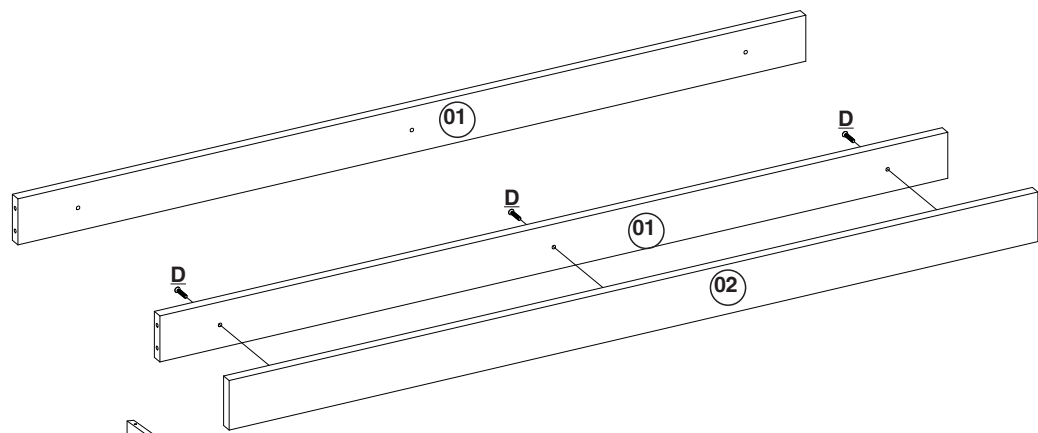

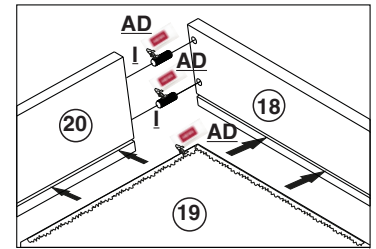
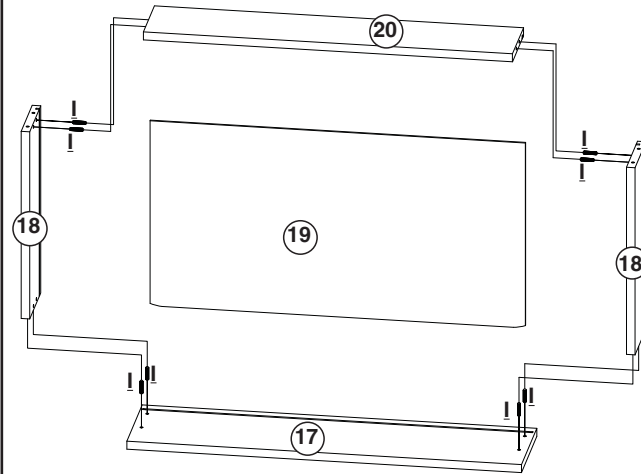

### Montagem da gaveta 2x



Utilize o sachê de cola (AD) nas cavilhas (I) e nos frisos da gaveta.

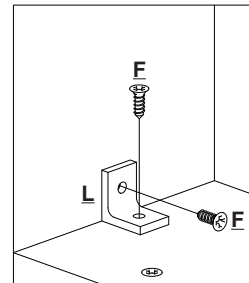

Fixação da cantoneira (L).

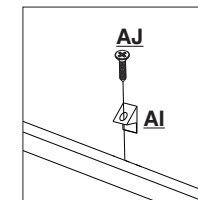
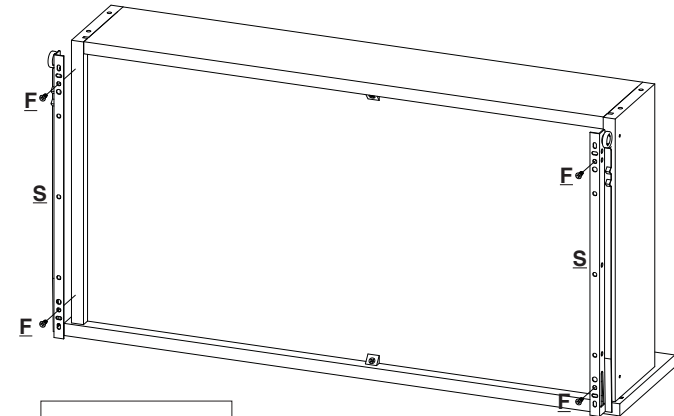

Fixação da cantoneira suporte triangular (AI).

### AVISO

Para limpeza de seu móvel, use uma flanela seca ou umedecida, e não utilize produtos químicos que possam danificar seu produto.

### SISTEMA DE MONTAGEM

O sistema de montagem dos produtos Henn, funciona de acordo com a ordem crescente dos números indicados no desenho. Ex: 01, 02, 03, 04... até a conclusão da montagem.

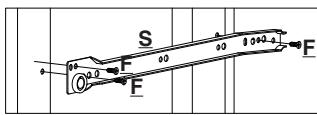
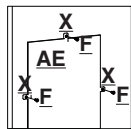
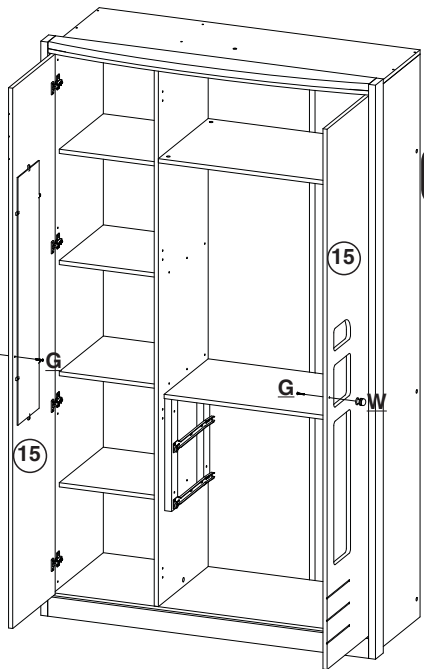

Fixação do vidro (AE).

Montagem das portas laterais - utilizar a dobradiça colo baixo (Q).

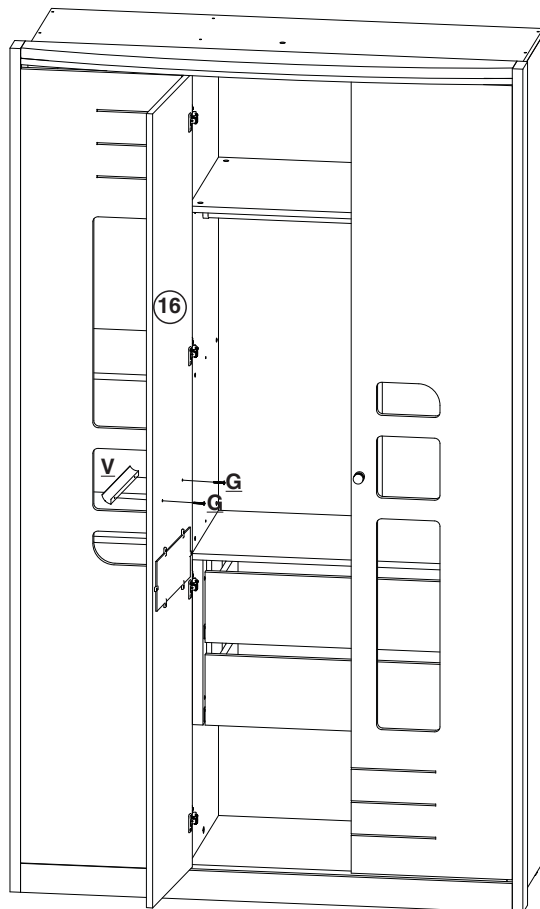
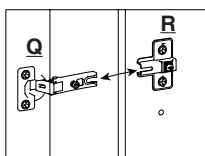
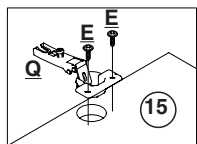
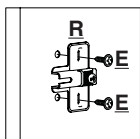

Montagem da porta central - utilizar a dobradiça colo alto (P).

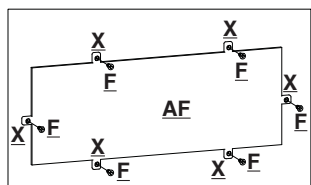
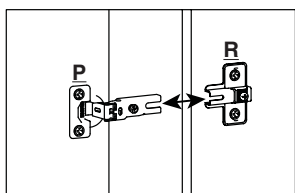
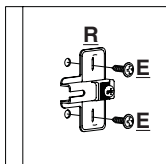
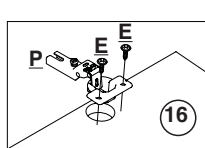

Fixação do vidro (AF).

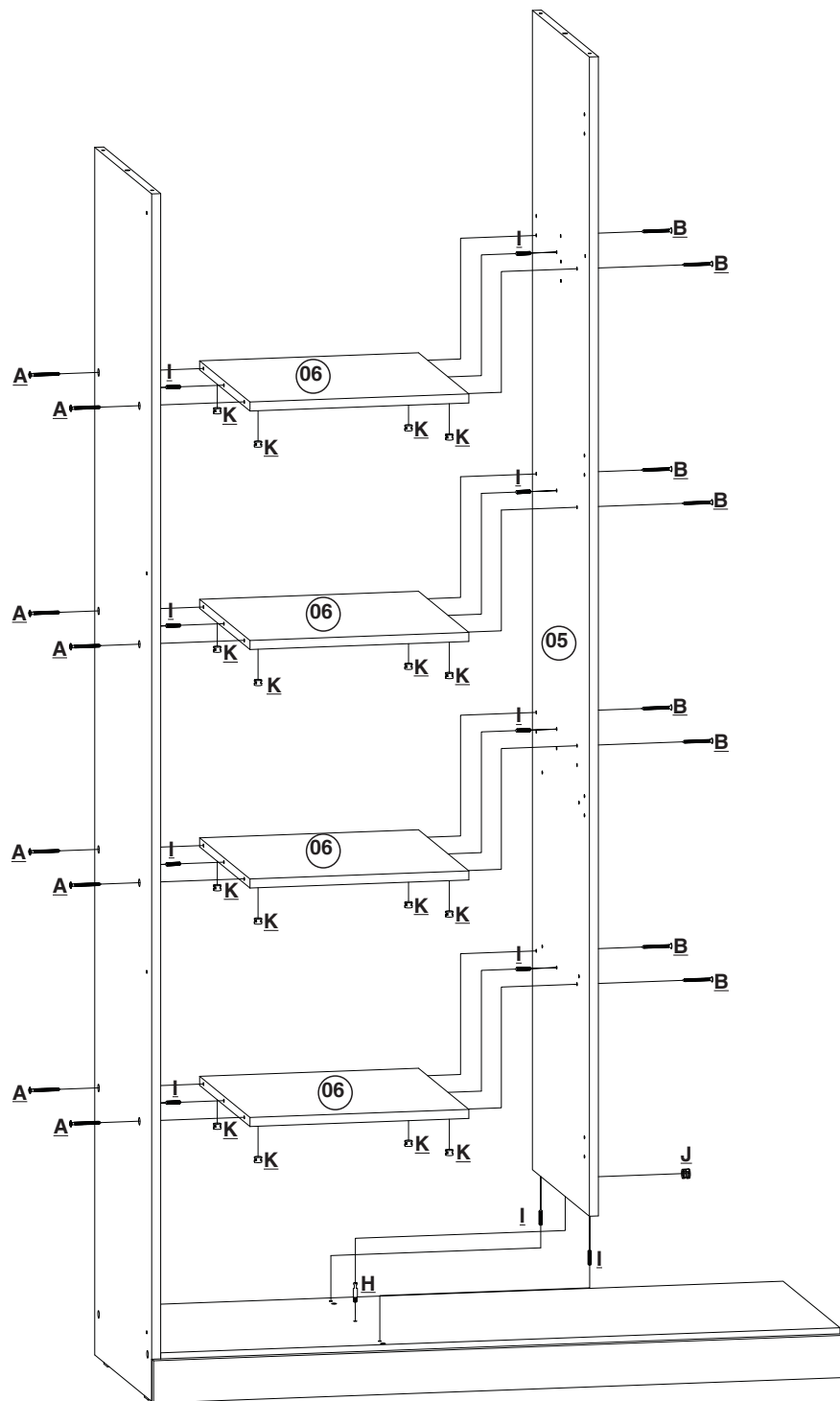

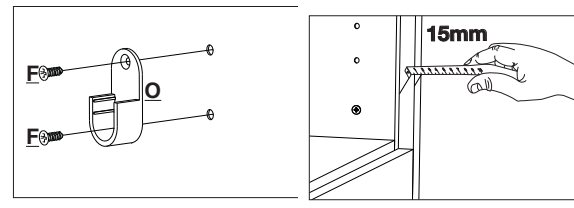
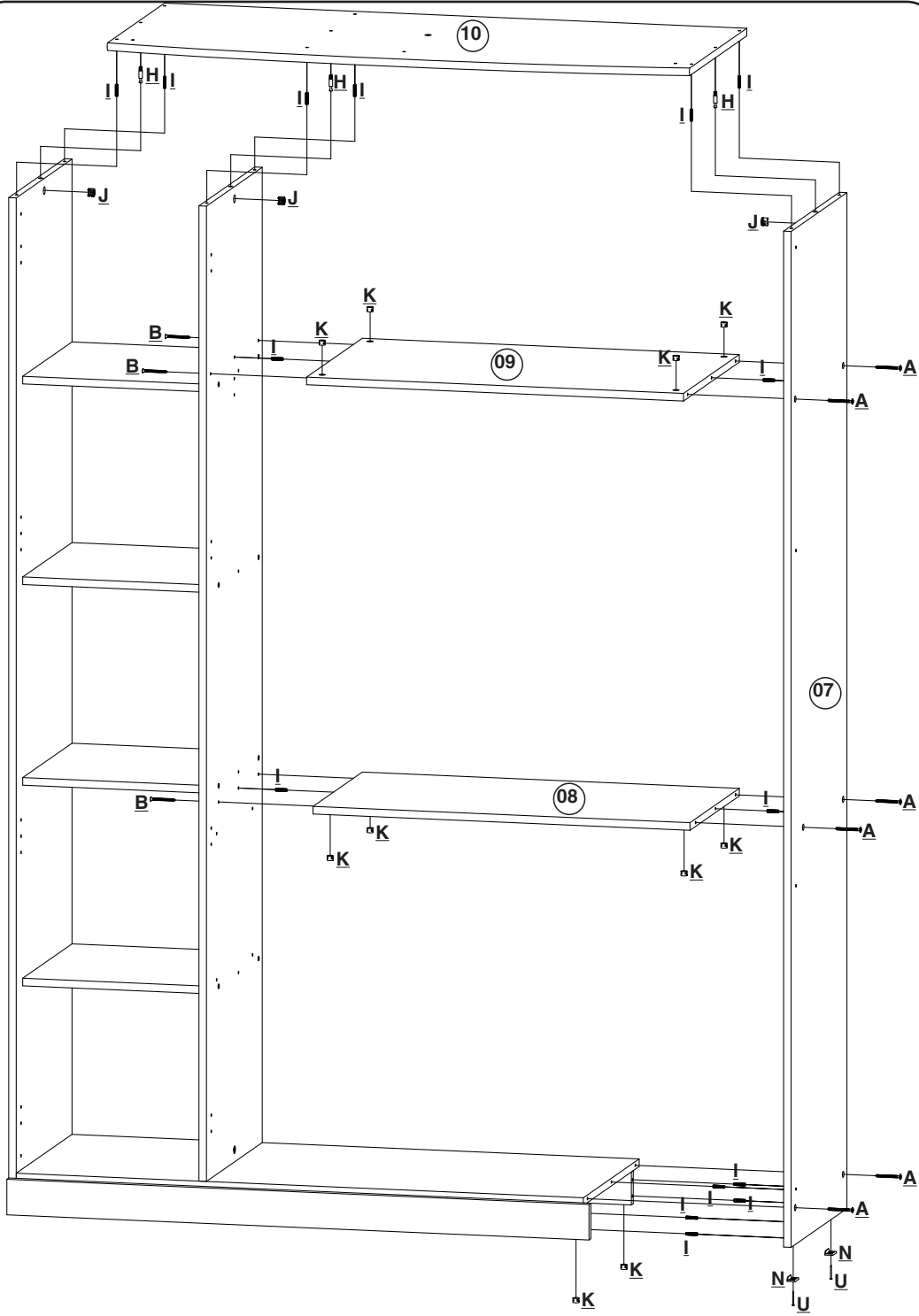

As molduras deverão ser fixadas a uma distância de 15mm para frente da lateral e do tampo superior, para um alinhamento correto com as portas.

