

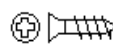













FERRAGEM

	CÓD.	FERRAGEM	QTDE
A	4214	 PARAFUSO 3,5x14	04
B	4042	 ZINCO PRETO 4,0x40	04
B	2592	 ZINCO BRANCO 4,0x40	04
C	2170	 TAMBOR MINIFIX	12
D	2170	 PARAFUSO MINIFIX	12
E	1802	 CAVILHA 6x30	32
F	10103	 TAMPA MINIFIX CARVALHO FRANCES	12
F	10104	 TAMPA MINIFIX VANILA	12
G	58	Kappesberg	01
H	85	 L' DE METAL	02
I	41	 COLA P/ CAVILHAS	01
J	10102	 BUCHA PARA SAPATA	04
K	10101	 SAPATA REGULAVEL	04
L	10109	 CHAVE ALLEN 6MM	01
M	1828	 3,5x14 PANELA	24
N	3941	 DOBRADIÇA RETA 26MM	06
□	3941	 CALÇO 5MM	06

"GARANTIA POR DEFEITO DE FABRICAÇÃO 6 MESES."

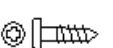

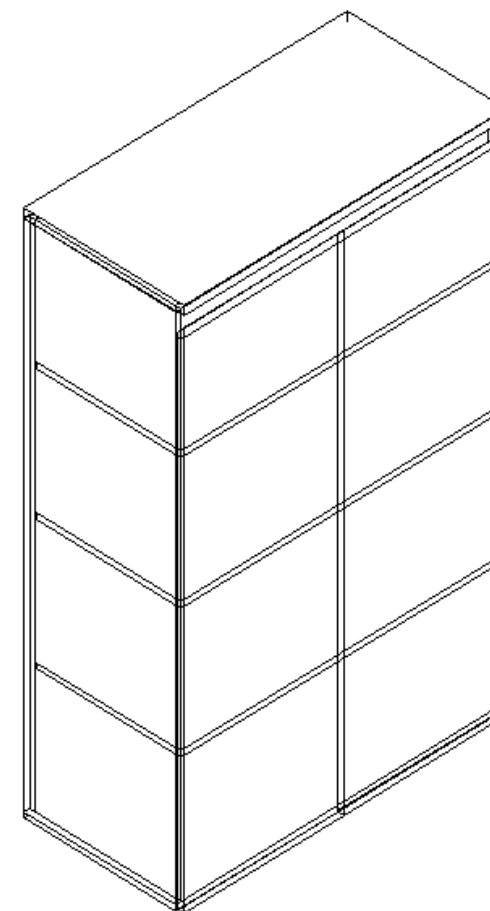
- 19089-TAMPO
- 19090-LATERAL DIREITA
- 19091-LATERAL ESQUERDA
- 19092-COSTA
- 19093-TRAVESSA
- 19094-BASE
- 19095-PRATELEIRA SUP. E INF.
- 19096-PRATELEIRA CENTRAL
- 19097-PORTA DIREITA
- 19098-PORTA ESQUERDA

OBS: Para solicitar assistência técnica, utilize o código das peças indicada.

OBS: Para solicitar assistência técnica, utilize o código da ferragem indicada.

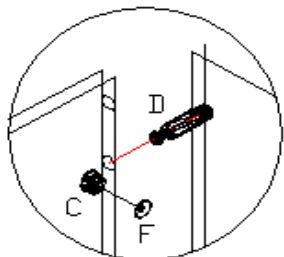

DETALHE MINIFIX

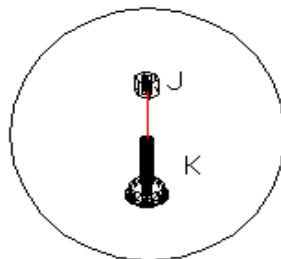

DETALHE SAPATA

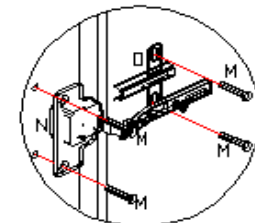
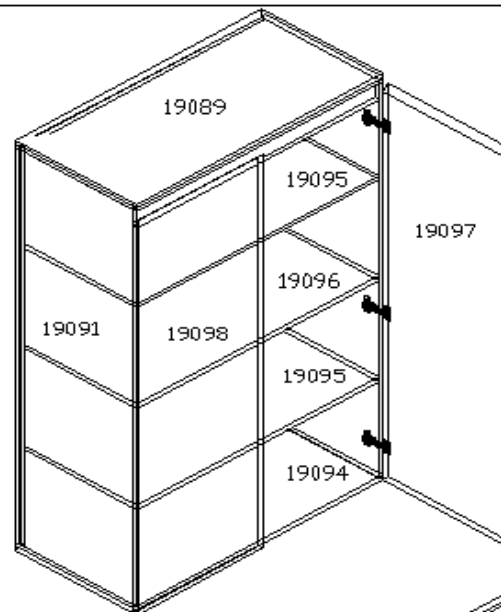
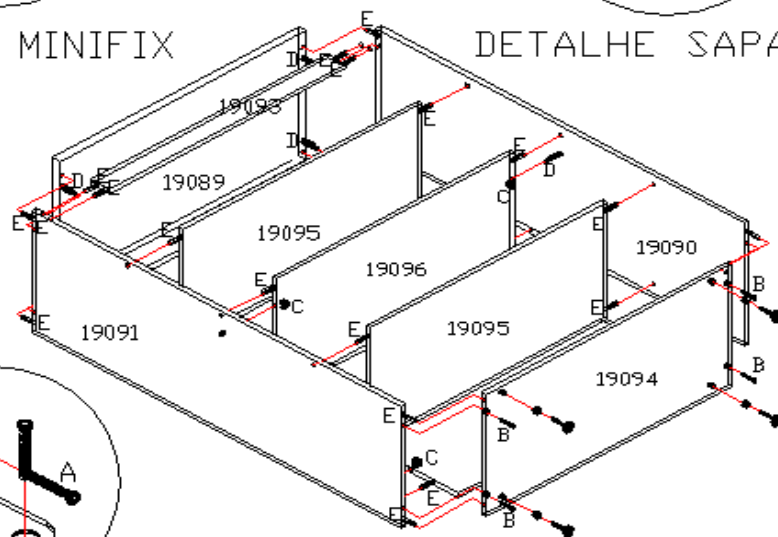

DOBRADIÇA

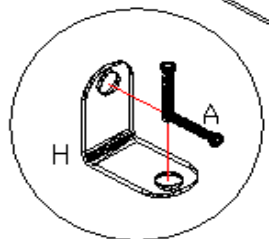

FIXAR AS TRAVESSAS COM OS "L" DE METAL E PARAFUSSOS "A".

USAR A CHAVE ALLEN PARA FIXAR AS BUCHA, ONDE SERÃO COLOCADAS AS SAPATAS.

COLOCAR UMA CAVILHA "E" NO MEIO DA COSTA PARA SE MANTER NA LINHA DA LATERAL.

