

Passo 1

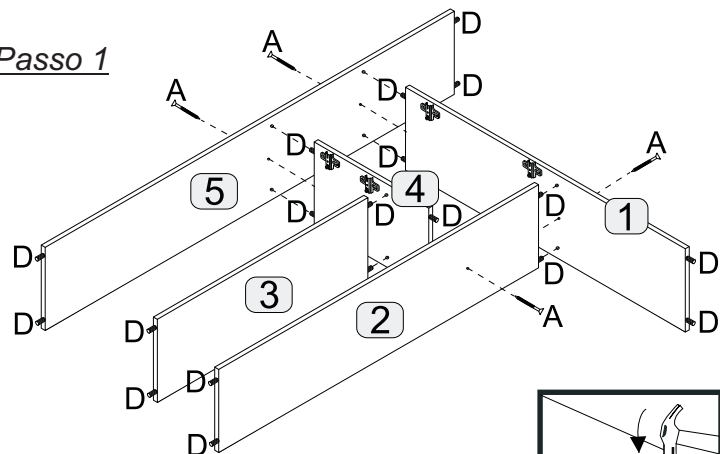

Passo 2

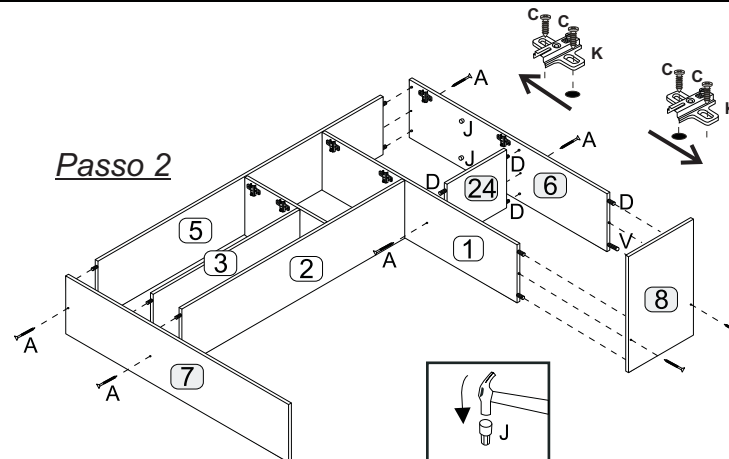

Passo 3

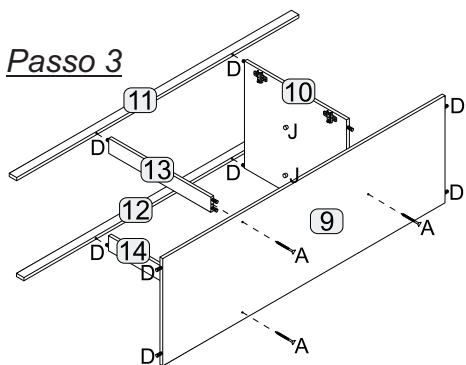

Passo 4

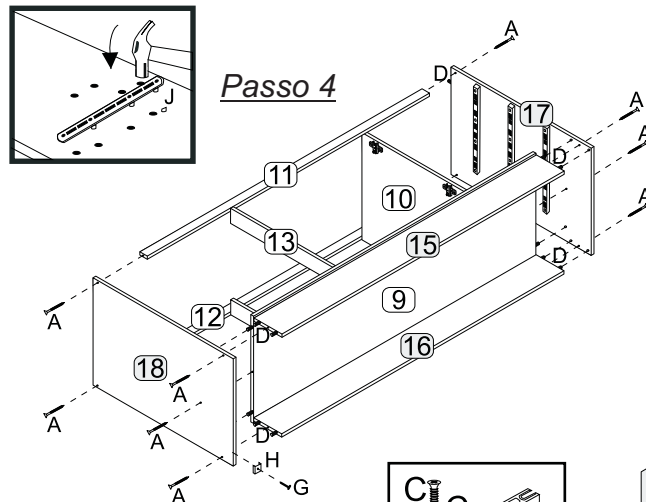

Passo 5

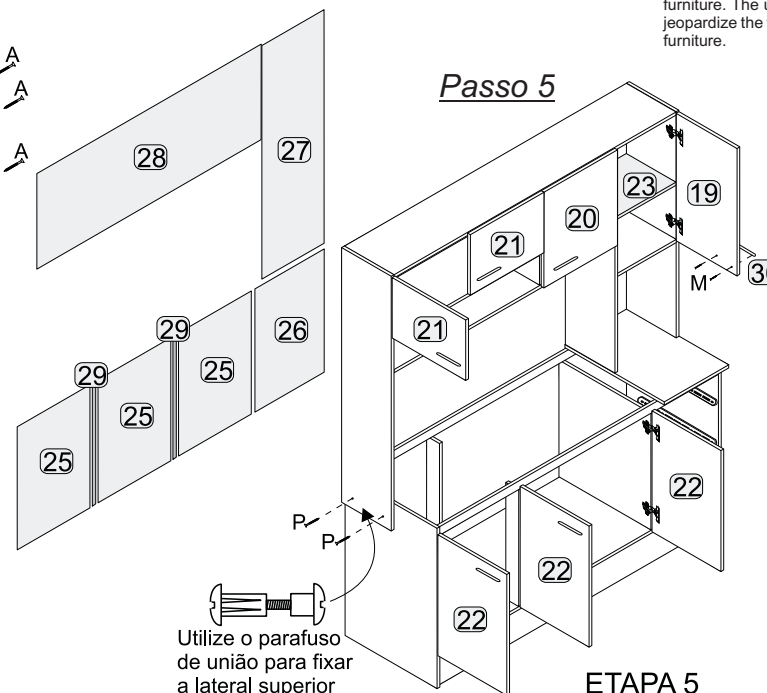

ETAPA 5

Utilize o parafuso de união para fixar a lateral superior com a lateral do balcão.

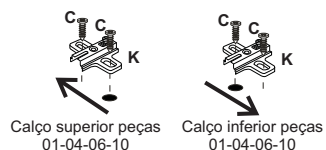

A marcação do calço será somente 1. Orientar-se pela indicação das figuras

ATENÇÃO montadores e consumidores:
 * Para limpar o móvel utilize somente um pano úmido (umedecido em água pura ou água com sabão neutro). Depois, passe um pano seco. Evite a umidade excessiva.

* Evite usar álcool, água sanitária, detergente e outros produtos químicos, mesmo diluídos em água. Não utilize produtos abrasivos de nenhuma espécie para limpar o móvel. A utilização de tais produtos pode comprometer as características finais do móvel.



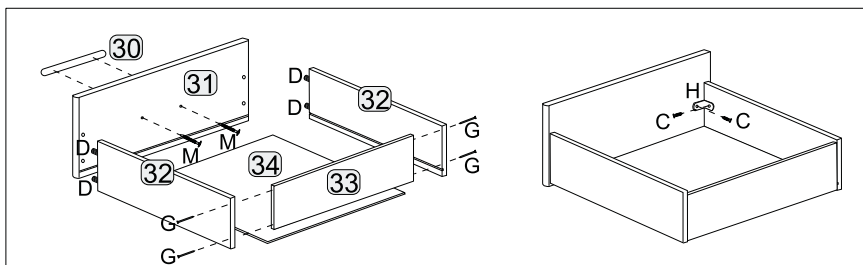











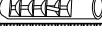

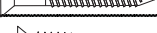

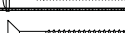
ATTENTION assemblers and consumers:
 - To clean the furniture, use only a damp cloth (humidify it only in pure water or water and neutral soap). After, use a dry cloth. Avoid excessive humidity.
 - Avoid using alcohol, bleach, detergent and other chemical products, even diluted in water. Do not use any kind of abrasive cleaning agents to clean the furniture. The use of such products may jeopardize the final characteristics of the furniture.

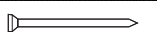

RELAÇÃO DE PEÇAS

Código Anterior	Código Novo	Descrição	Quantidade
01	0500133	DIVISORIA 1050X270X15 MM P	1
02	0500251	BASE 1200X270X15 MM P	1
03	0500252	BASE 790X270X15 MM P	1
04	0500134	DIVISORIA 430X270X15 MM P	1
05	0501014	BASE 1535X270X15 MM P	1
06	0500048	LATERAL 1065X270X15 MM P	1
07	0500049	LATERAL 1200X270X15 MM P	1
08	0500838	TAMPO 525X350X15 MM P	1
09	0500254	BASE 1520X497X15 MM P	1
10	0500112	DIVISORIA 550X497X15 MM P	1
11	0500839	TRAVESSA 1520X40X15 MM P	1
12	0501010	TRAVESSA 1520X40X15 MM P	1
13	0500840	PILASTRA 550X70X15 MM P	1
14	0500840	PILASTRA 550X70X15 MM P	1
15	0500841	RODAPE 1520X150X15 MM P	1
16	0501012	RODAPE 1520X150X15 MM P	1
17	0500059	LATERAL 755X497X15 MM P	1
18	0500059	LATERAL 755X497X15 MM P	1
19	0500842	PORTA 600X331X15 MM P	1
20	0500843	PORTA 450X400X15 MM P	1
21	0500844	PORTA 398X285X15 MM P	2
22	0500845	PORTA 570X375X15 MM P	3
23	0500846	PRATELEIRA 320X260X15 MM P	1
24	0500255	BASE 320X270X15 MM P	1
25	0500847	COSTA 590X377X2,8 MM P	3
26	0500848	COSTA 590X398X2,8 MM P	1
27	0500849	COSTA 1100X338X2,8 MM P	1
28	0500850	COSTA 1220X450X2,8 MM P	1
31	0500851	FRENTE DE GAVETA 391X187X15 MM P	3
32	0500852	LATERAL DE GAVETA 440X112X15 MM P	6
33	0500853	BATENTE 346X90X15 MM P	3
34	0500854	FUNDO DE GAVETA 445X357X2,8 MM P	3

RELAÇÃO DE ACESSÓRIOS

Código Anterior	Código Novo	Descrição	Figura	Quantidade
D	01211	CAV MAD 6X30 MM		54
F	01213	COLA SAQ		2
K	01268	DOB MET CANECA 260 MM		14
N	01270	CANT MET		6
U	01311	BUCHA 8 MM		2
R	01315	PF UNIAO		1
M	01317	PF 4X25		20
A	01318	PF 4X45		24
C	01319	PF 4X16		32
T	01320	PF 5X45		2
P	01321	PF 5X30		2
B	01328	PF 3,5X12		40
G	01329	PR 13X15		12
H	01330	PR 10X10		90
I	01345	PUX 151 CROM BRILHO		10
Q	01367	SAPATA L PAST 15X15 MM		6
J	01368	SUP PRAT 8X6 MM		4
S	01373	SUP AEREO MET CAPA BRC		2
E	01220	CORREDIÇA PLAST 150 MM		9
L	01247	PERFIL 600 MM BRC/MAF		2