

RELAÇÃO DE ACESSÓRIOS

A	PARAFUSO FI CH PH 4,5 x 50	39
B	KIT FECHO GANGORRA C/ PARAFUSO	01
C	PORCA SX MA 4	04
D	DOBRA METAL 26mm	18
E	PARAFUSO MQ PN PH 4 X 25	04
F	CAVILHA MADEIRA 6 x 25	78
G	PORCA CILINDRICA 12 X 09	30
H	CANTONEIRA METAL	20
I	SAPATA MINI LAT. 12mm	08
J	CUNHA	04
K	PREGO 12 x 12	08
L	PREGO 10 x 10	134
M	CALÇO P/ DOBRA 5mm	18

N	SUPORTE CABIDEIRO CINZA	06
O	FIXADOR DE FUNDO	30
P	PUXADOR AUSTRIA 160mm	06
Q	CORREIÇA METAL	04
R	KIT CHAVE HAVANA C/ PARAFUSO	01
S	PARAFUSO FI CH ZB 4,0 x 12	148
T	PARAFUSO FI CH PH 3,5 x 35	08
U	COLA PVA	01
V	SUPORTE P/ PRATELEIRA	04
W	PUXADOR AUSTRIA 320mm	04
X	PARAFUSO P/ PUXADOR FI FL PH 3,5 X 30	20

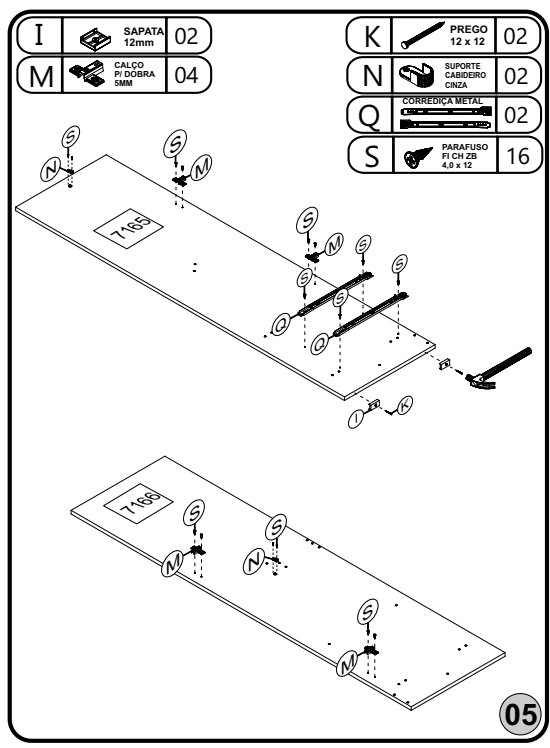

03

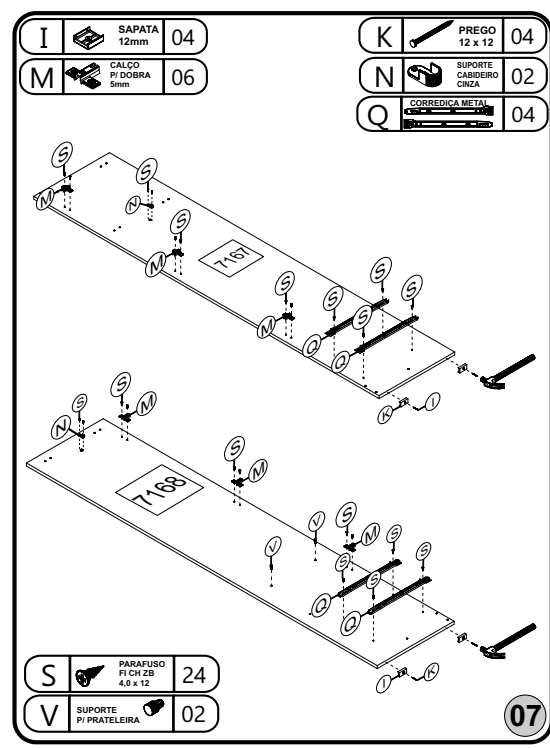

05

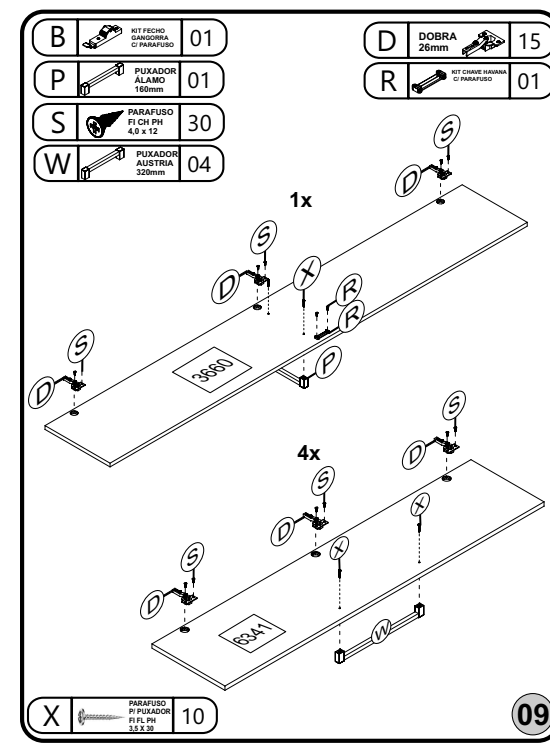

07

RELAÇÃO DE PEÇAS	Nº	TAMANHO	QTDE
TAMPO/CHAP/BASE INF.	629	582x448x12	03
VISTA CENTRAL	04	592x73x15	02
TRAVA	01	582x50x12	02
FUNDO DO COFRE	02	582x156x03	01
LAT. EXT. ESQUERDA	7167	2045x448x12	01
LAT. EXT. DIREITA	7168	2045x448x12	01
LAT. INT.ESQUERDA	7165	1594x448x12	01
BASE MALEIRO	3664	1176x448x12	01
TAMPO DO COFRE	2197	580x260x12	01
TESTEIRA FRONTAL	2198	582x75x12	01
TESTEIRA TRASEIRA	2199	582x70x12	01
CHAPEU	3658	1770x448x12	01
TRASEIRO DE GAVETA	7063	533x090x12	04
RODAPE FRONT/TRASEIRO	3982	582x71x12	04
FUNDO DE GAVETA	09	555x365x03	04
TRASEIRO GR.	06	1896x597x03	02
PORTA	3660	1886x294x15	01
PORTA P/ FECHADURA	3659	1886x294x15	01
FRENTE DE GAVETA	7060	592x171x15	04
CABIDEIRO ECO FRIZADO	08	576 MM	03
PORTA	6341	1458x294x15	04
BATENTE	3329	356x95x12	01
LAT. INT. DIREITA	7166	1962x448x12	01
BATENTE	3662	356x60x12	01
PRATELEIRA	5530	582x448x12	01
TAMPO	3599	582x448x12	01
VISTA SUPERIOR/INFERIOR	03	1794x73x15	02
PERFIL	07	1896MM	01
LATERAL DE GAVETA ESQ.	6961	357x101x12	04
LATERAL DE GAVETA DIR.	6961	357x101x12	04
TRASEIRO GR	05	1896x294x03	02

04

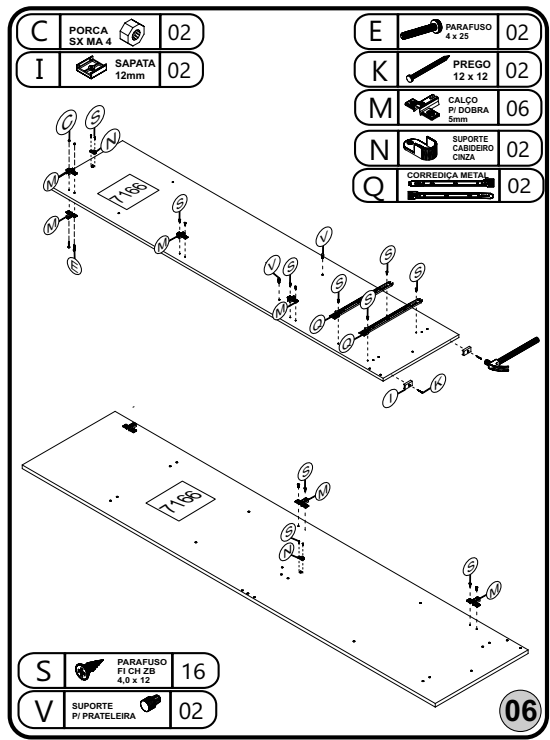

06

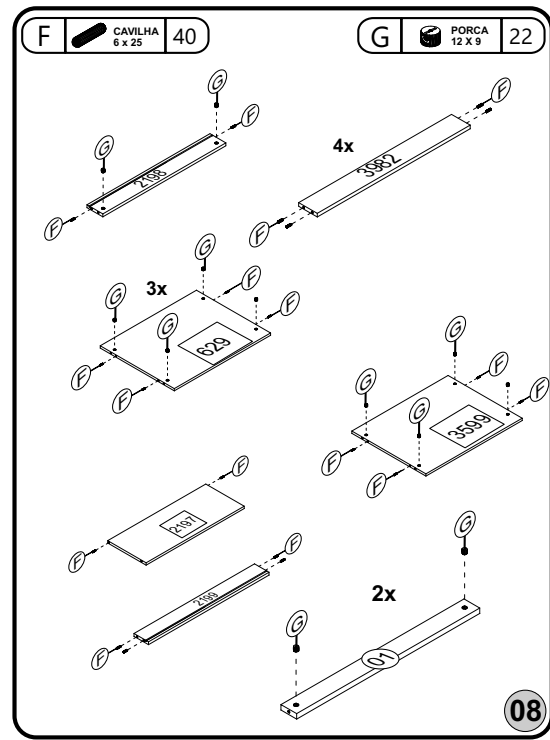

08

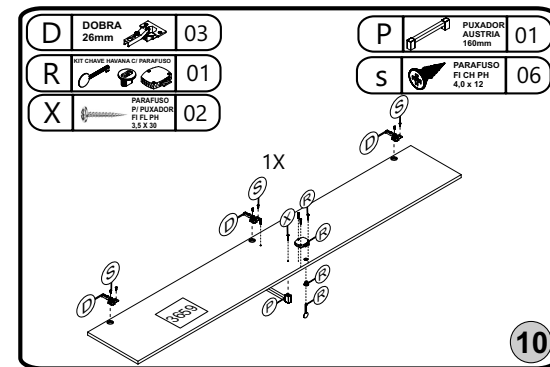

10

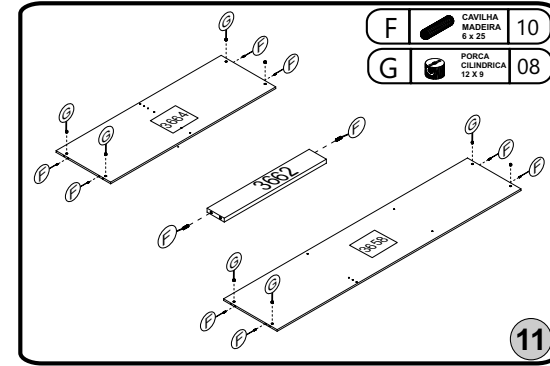

11