

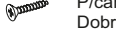







Acessórios

-  Paraf. Ø4x45 mm
Montagem estrutura 16
-  Par. Ø3,5x25 mm
puxador e união 16
-  Par. Ø3,5x14 mm
P/cantoneiras,
Dobradiça e calço 22
-  Cavilha Ø6x30 mm
Montagem estrutura
Gavetas e rodapés 04
-  Ø26mm
Dobradiça CURVA 04
-  Calço 5 (Baixo) 04
-  Puxador Klar 2
-  Junção 8
-  Cantoneira
P/ Moldura Superior 3
-  Pregos 10 x 10
Fundos 50
-  Cola branca(sache)
P/cavilhas 1
-  Tapa furos 12
-  KIT
Suporte aéreo
c/ capa. 1
6 paraf. Ø4 x 13mm
2 paraf. Ø6 x 60mm
2 bucha Ø8mm

Montagem da Estrutura

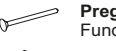

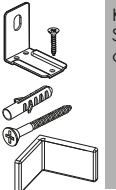
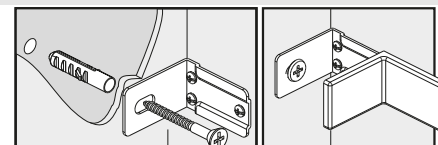
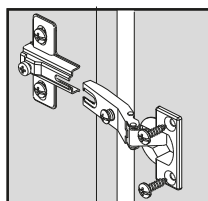
Fixe a cantoneira na lateral.
Posicione o módulo e através
das cantoneiras, fixe na parede
com bucha e parafuso.

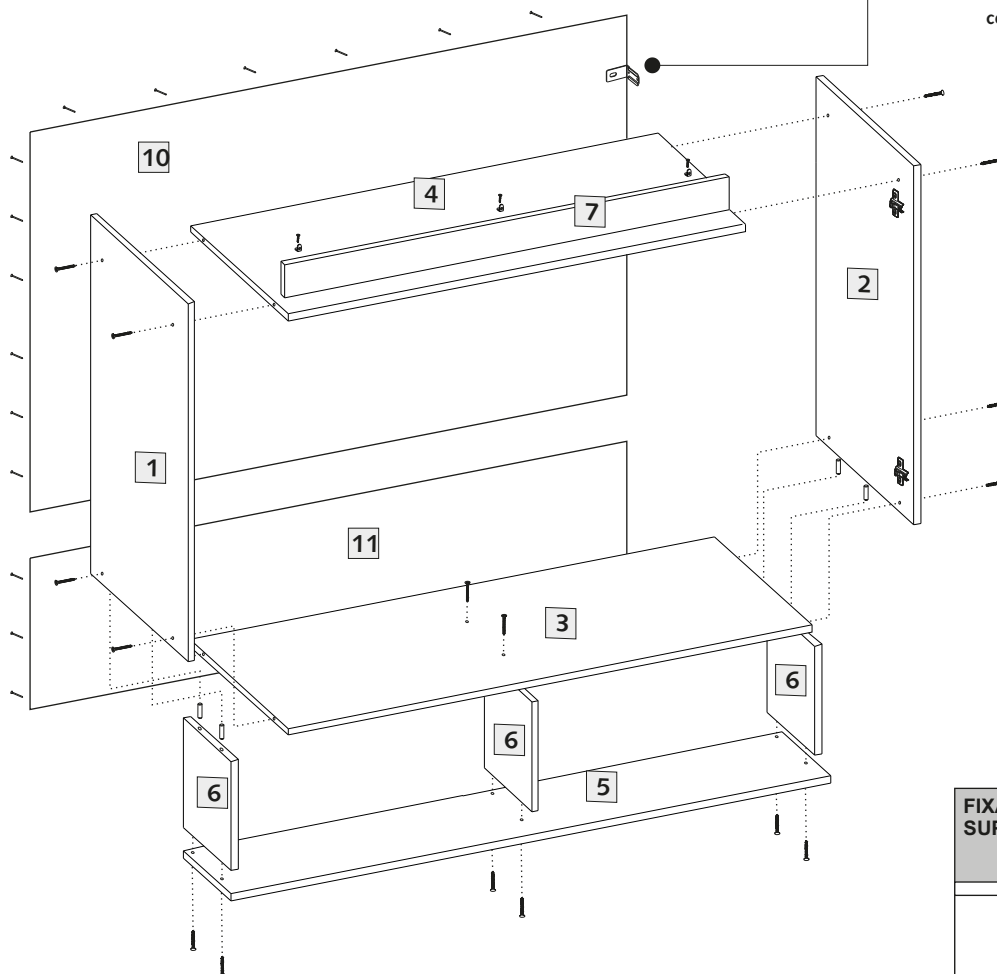

**COLOCAR COLA EM TODAS AS FURAÇÕES
DE CAVILHAS**

FIXAÇÃO MOLDURA SUPERIOR

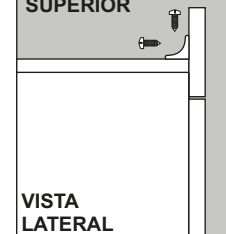

VISTA
LATERAL

ATENÇÃO!

Fixar a moldura superior
de acordo com o desenho.

Armário PONTE 0,97m SMART

Larg.: 970mm Alt.: 1040mm Prof.: 415mm

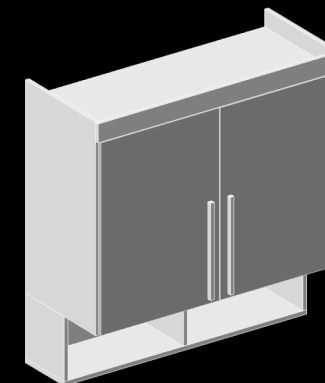

Item	Componente	QT.	ALT. X LARG.	Assist.Téc.
01	Lateral Esquerda	01	770 x 400	
02	Lateral Direita	01	770 x 400	
03	Base Maleiro	01	220 x 940	
04	Chapéu	01	400 x 940	
05	Base Nicho	01	220 x 970	
06	Divisão Nicho	03	255 x 220	
07	Moldura Superior	01	70 x 970	
08	Portas	02	695 x 473	
09	Fundo Maior	01	967 x 700	
10	Fundo menor	01	967 x 275	

Conservação e Limpeza

Para a limpeza basta utilizar pano macio ligeiramente úmido.
Não use álcool ou abrasivos que poderão danificar a camada de verniz.



EUCAMÓVEIS