

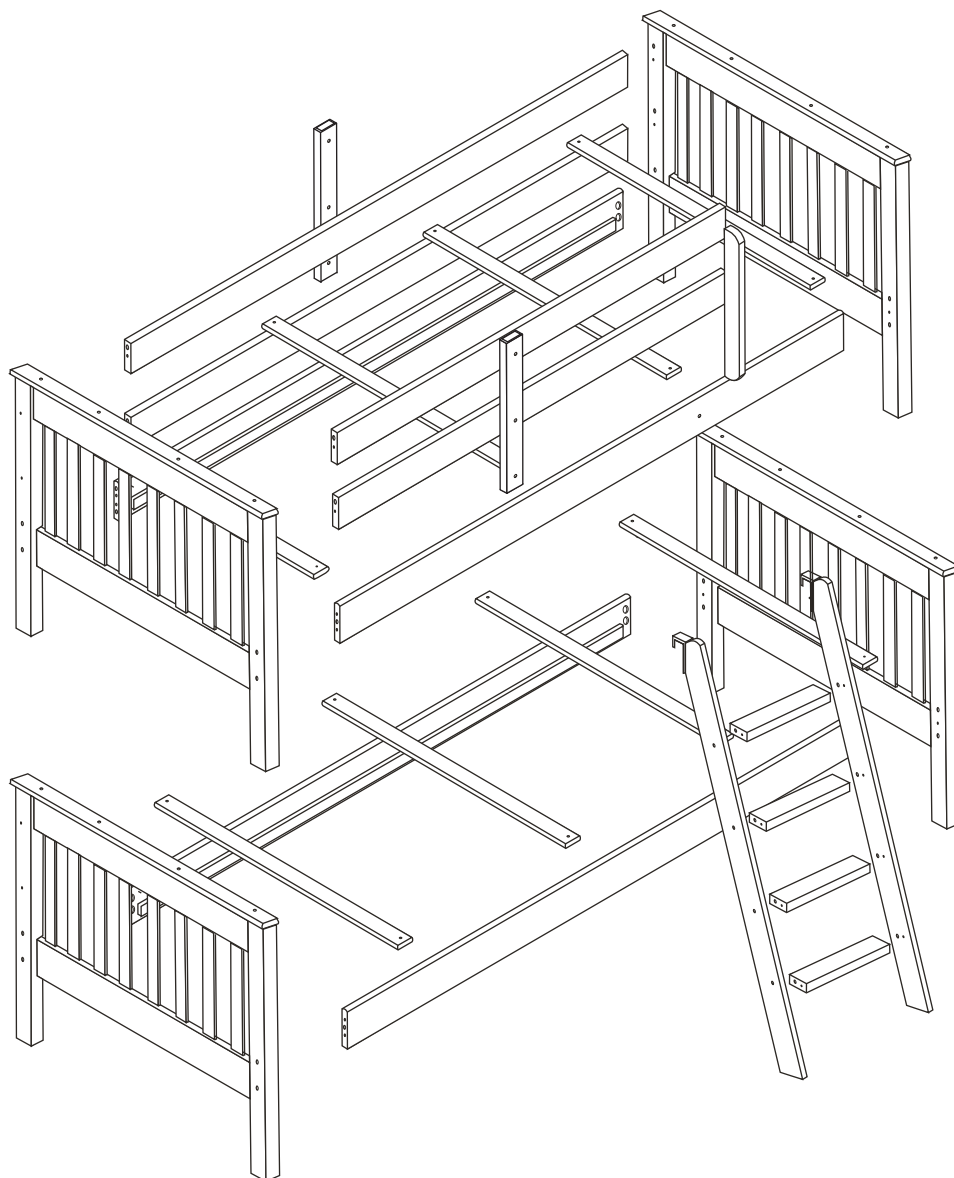









721 - BELICHE PIRATINI



LISTA DE COMPONENTES - IDENTIFICANDO ATRAVÉS DAS ILUSTRAÇÕES ABAIXO.

A  1/4 x 110 Parafuso Qtd 16	B  1/4" PORCA MEIA LUA Qtd 16	C  70 x 50 Parafuso Qtd 11
D  7,0 x 100 Parafuso Qtd 06	E  4,0 x 35 Parafuso Qtd 78	F  CHAVE ZETA Qtd 01
G  10 x 110 Cavilhas de Madeira Qtd 04	H  3,5 x 16 Parafuso Qtd 06	I  10 x 40 Cavilhas de Madeira Qtd 26
J  GANCHO Qtd 02		

01

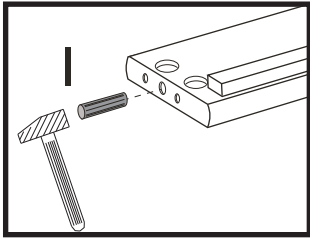

ATENÇÃO!

MARCAS PERFORADAS

BARRAS DE PROTEÇÃO/CAMA SUPERIOR

X1

X3

X2

X2

X4



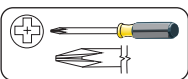
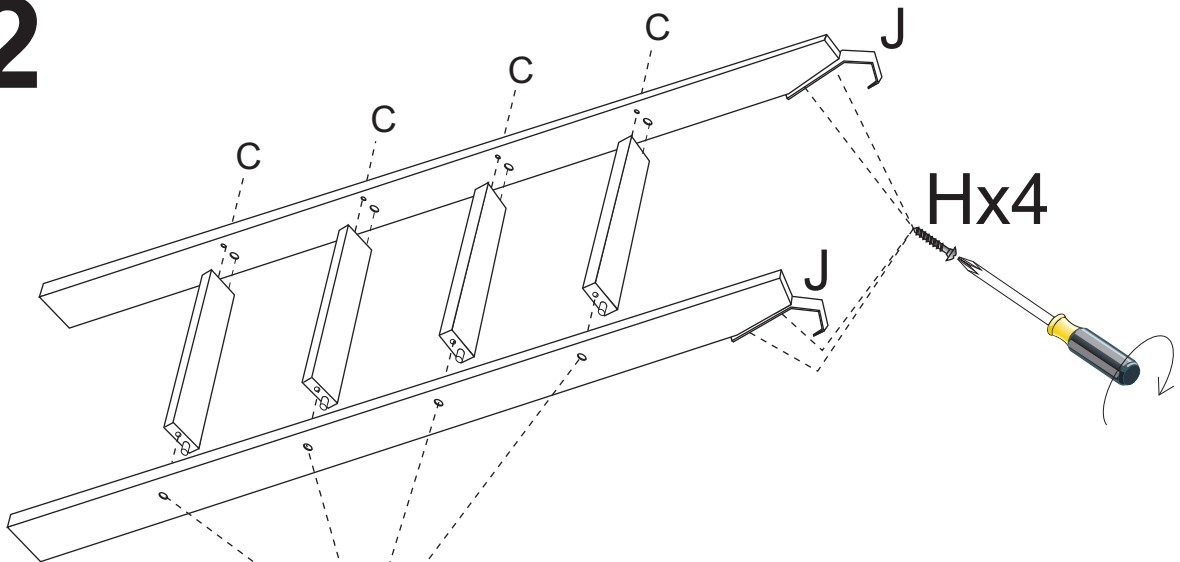

10 x 40 Cavilhas de Madeira Qtd 22

02



F  Qtd 01
Chave Zeta

H  Qtd 04
3,5 x 16 Parafuso

J  Qtd 02
GANCHO

C  Qtd 08
7,0 x 50 Parafuso

03

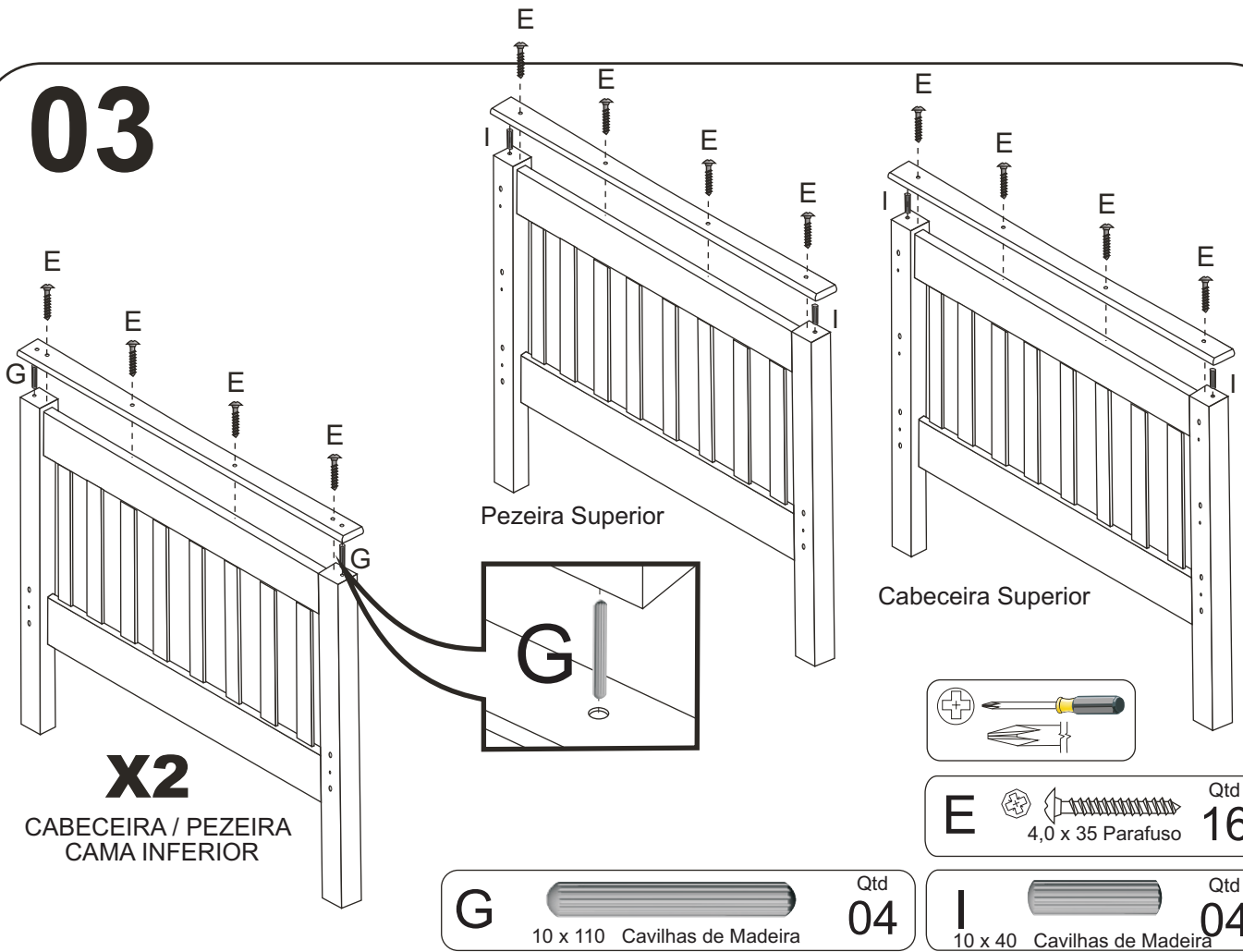

04

CAMA INFERIOR

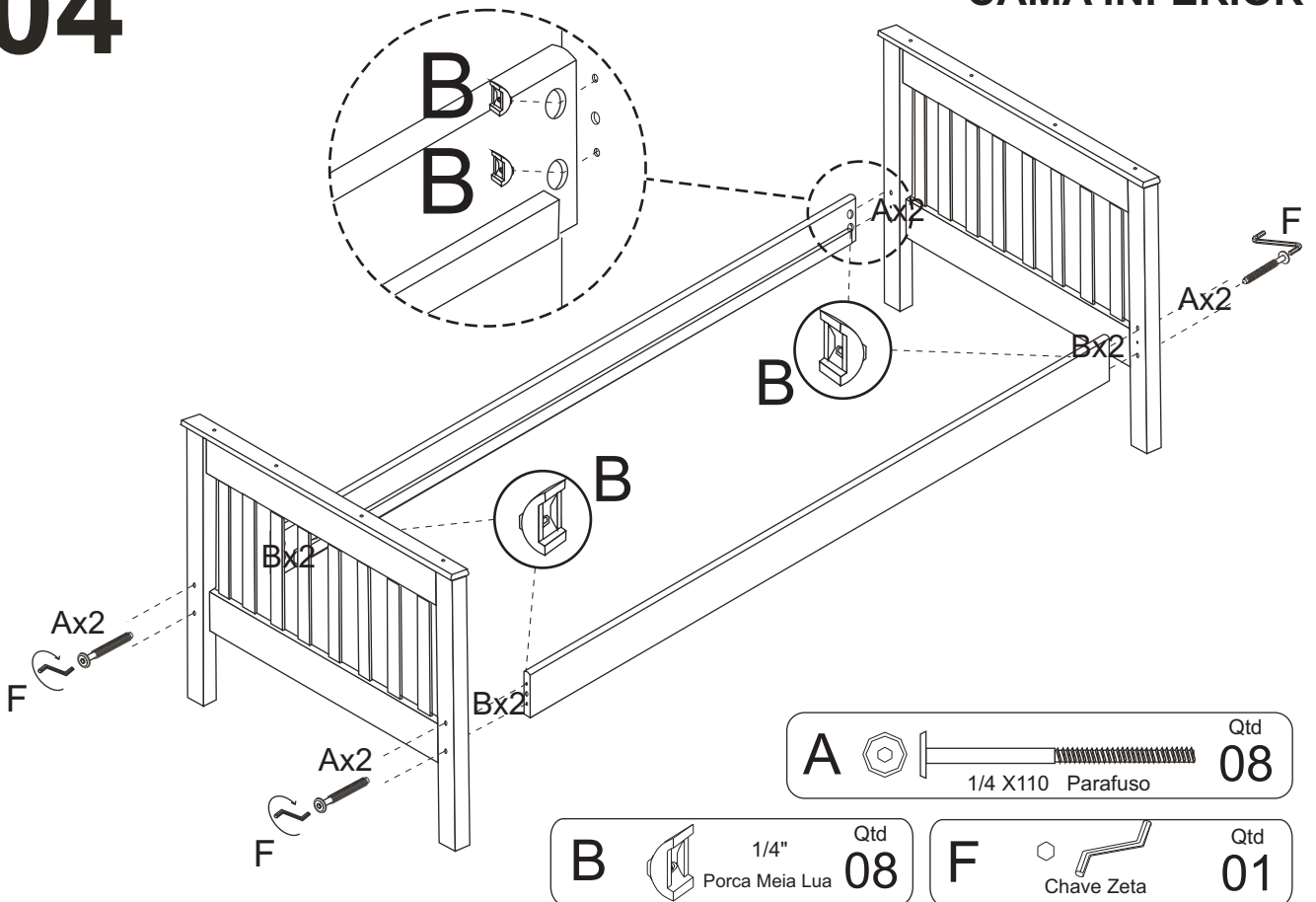

05

CAMA INFERIOR

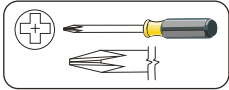
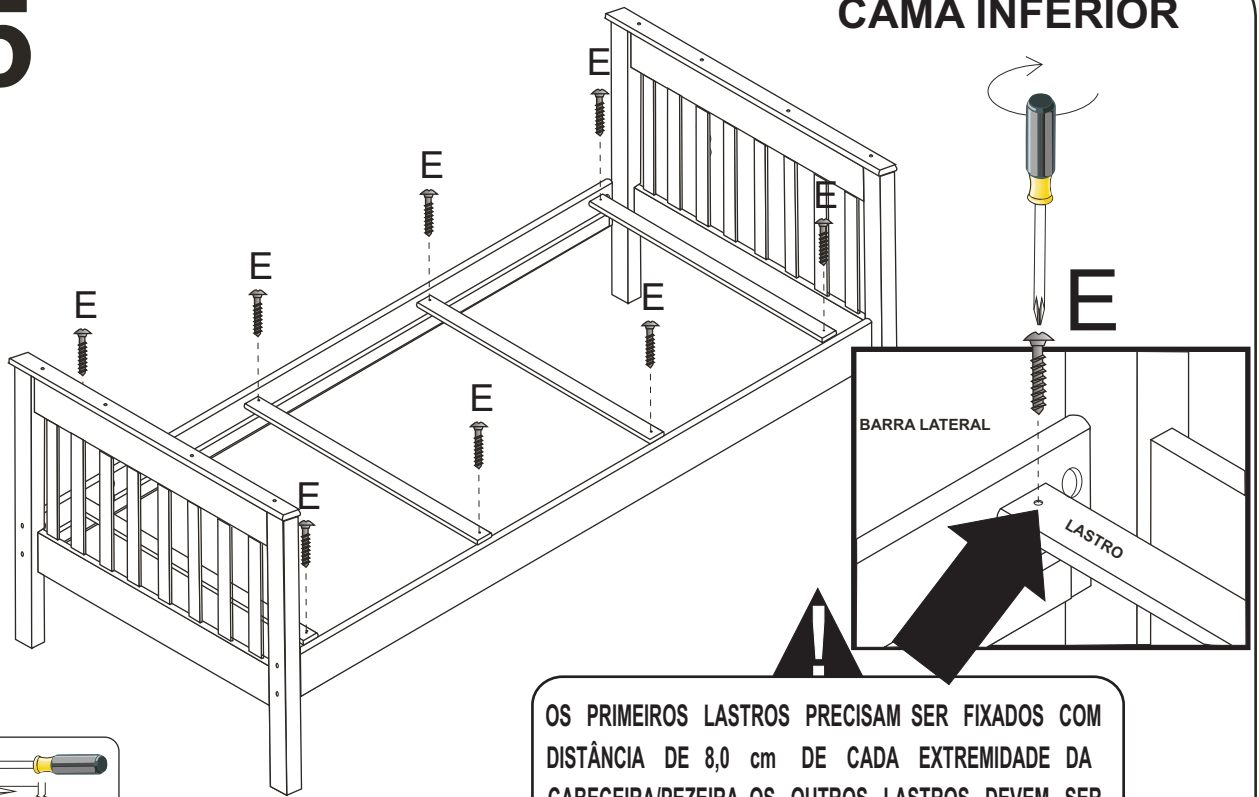

E  Qtd **28**
4,0 X 35 Parafuso

OS PRIMEIROS LASTROS PRECISAM SER FIXADOS COM DISTÂNCIA DE 8,0 cm DE CADA EXTREMIDADE DA CABECEIRA/PEZEIRA. OS OUTROS LASTROS DEVEM SER FIXADOS ENTRE ELES, NA DISTÂNCIA APROXIMADA DE 8,0 cm.

06

CAMA SUPERIOR

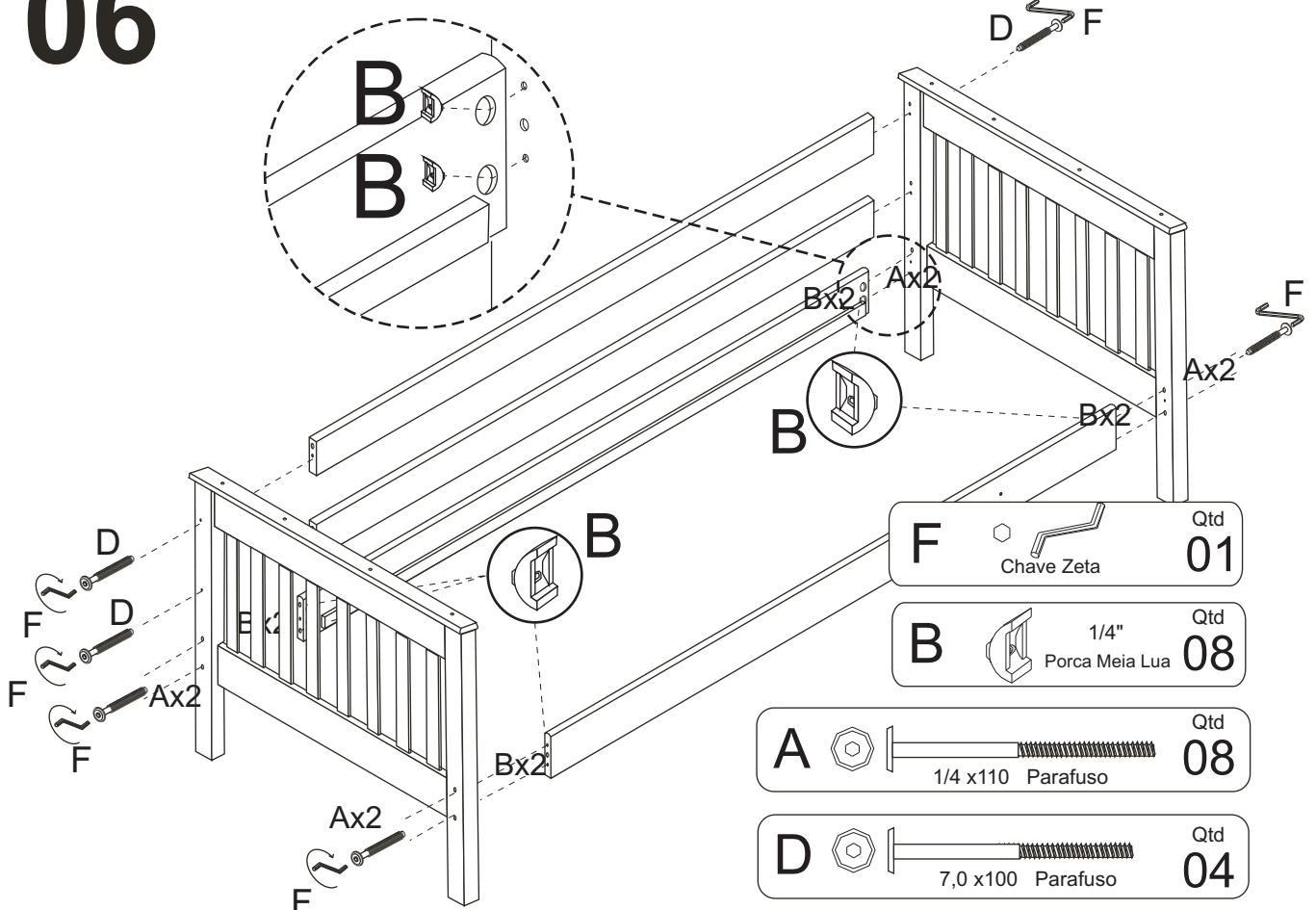

F  Qtd **01**
Chave Zeta

B  Qtd **08**
1/4" Porca Meia Lua

A  Qtd **08**
1/4 x110 Parafuso

D  Qtd **04**
7,0 x100 Parafuso

07

CAMA SUPERIOR

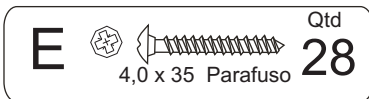
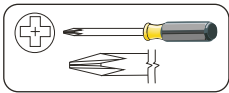
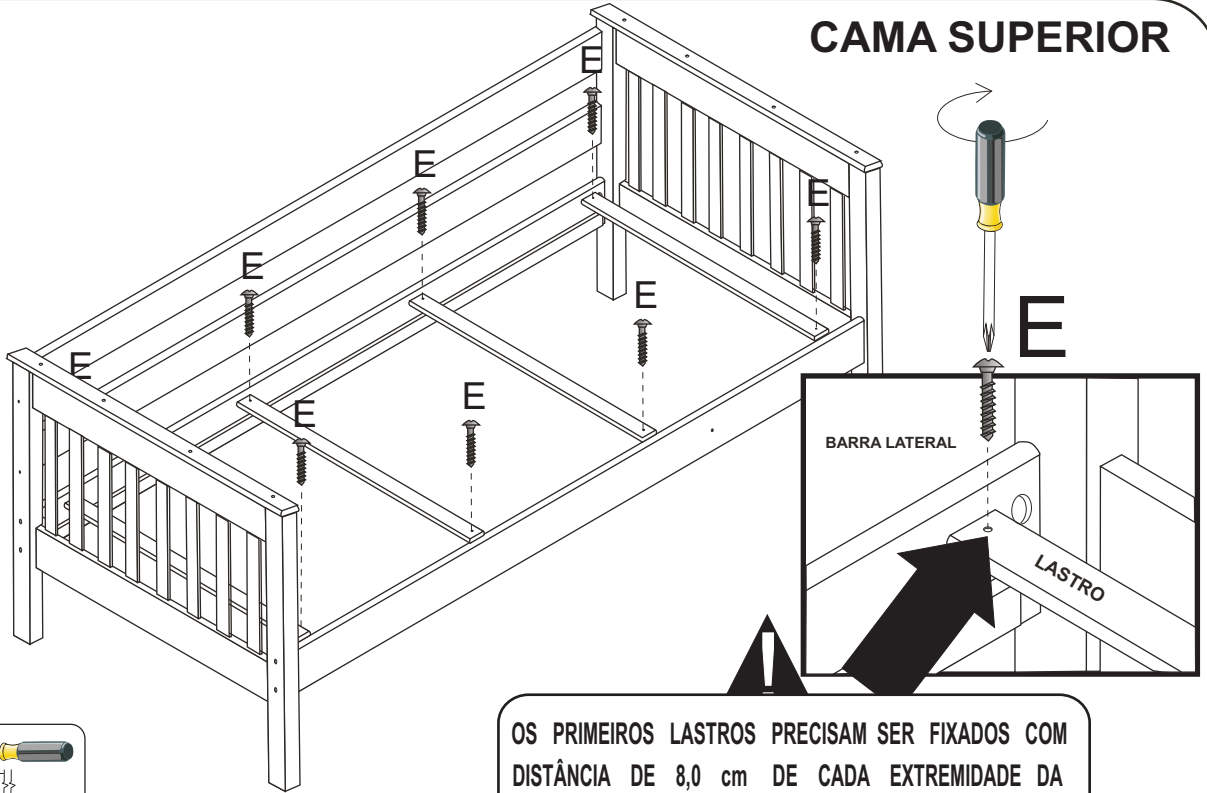

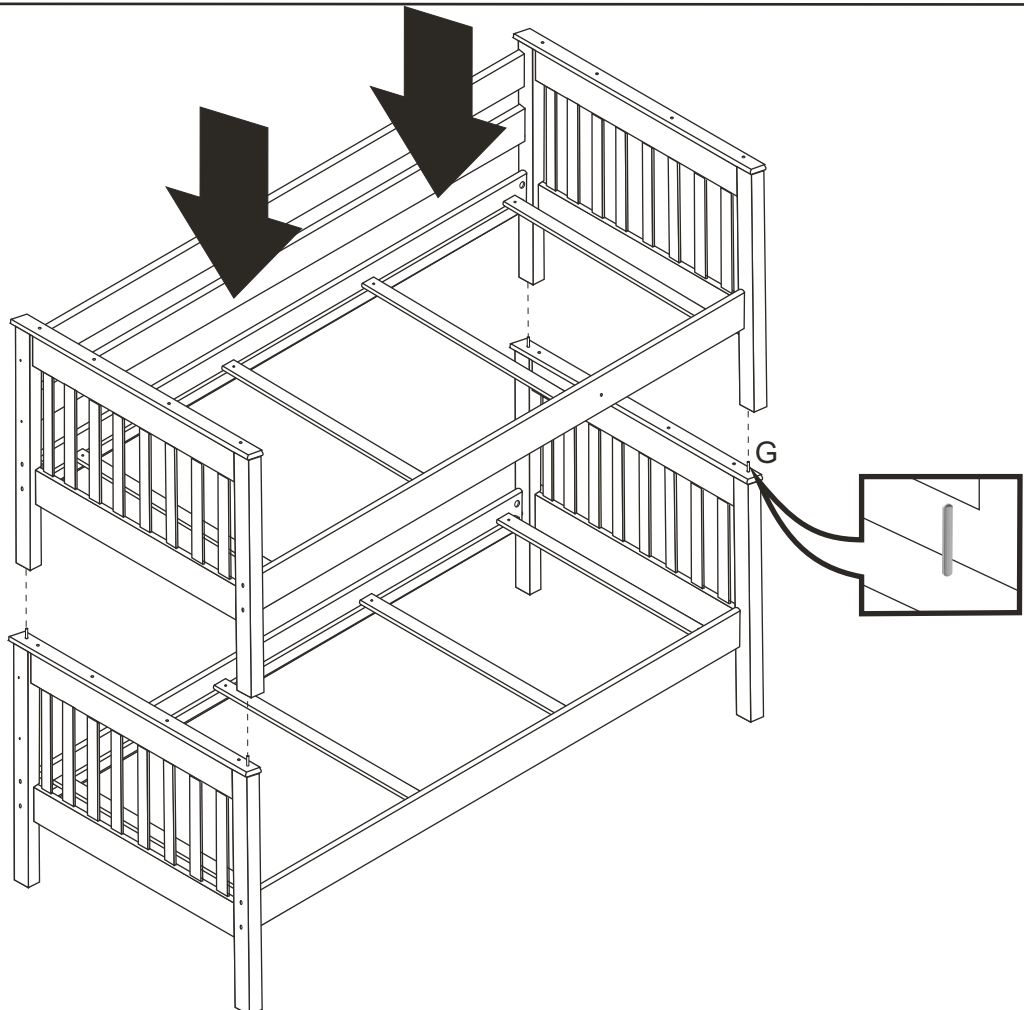

OS PRIMEIROS LASTROS PRECISAM SER FIXADOS COM DISTÂNCIA DE 8,0 cm DE CADA EXTREMIDADE DA CABECEIRA/PEZEIRA. OS OUTROS LASTROS DEVEM SER FIXADOS ENTRE ELES, NA DISTÂNCIA APROXIMADA DE 8,0 cm.

08

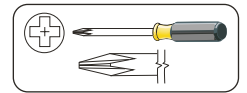
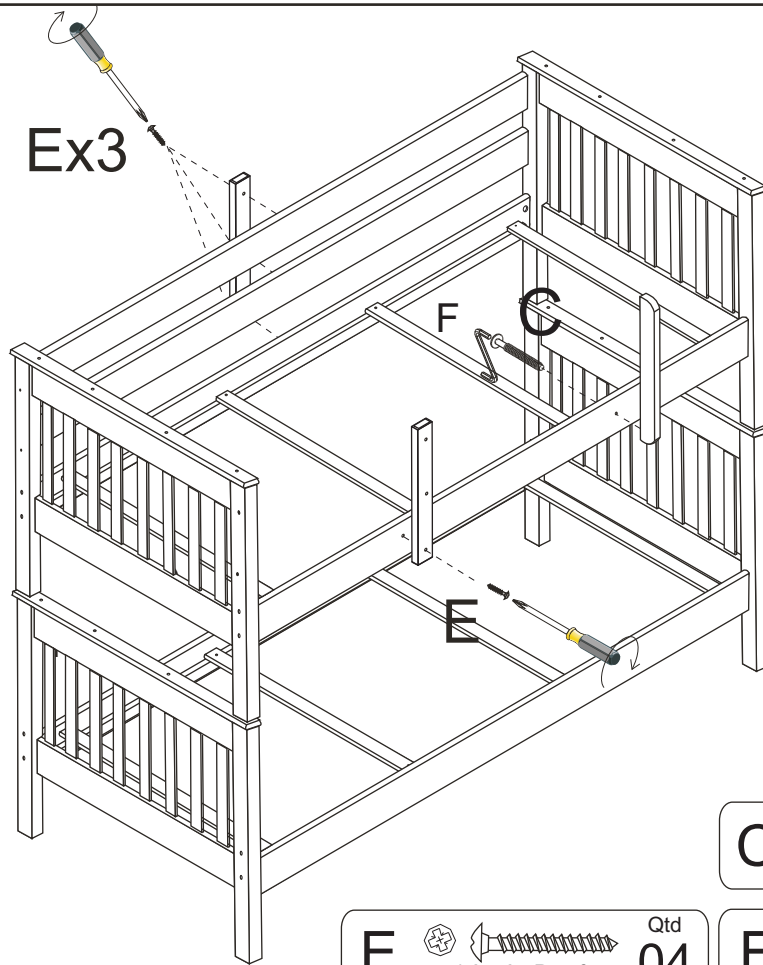

09





C   Qtd **01**
7,0 x 50 Parafuso

E  Qtd **04**
4,0 x 35 Parafuso

F  Qtd **01**
Chave Zeta

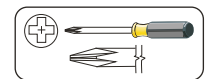
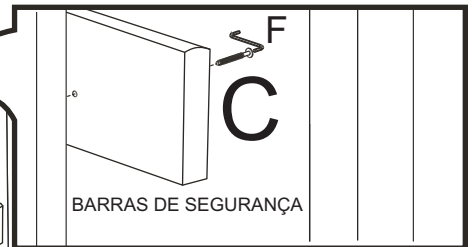
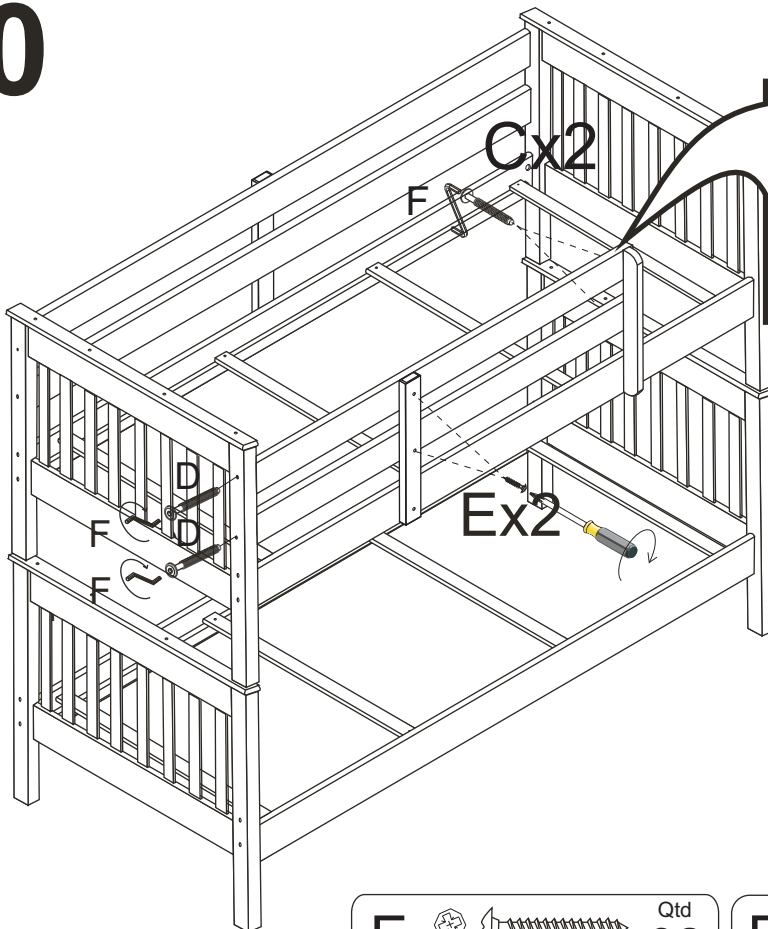
10



C   Qtd **02**
7,0 x 50 Parafuso

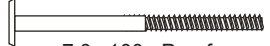

F  Qtd **01**
Chave Zeta

E  Qtd **02**
4,0 x 35 Parafuso

D   Qtd **02**
7,0 x 100 Parafuso

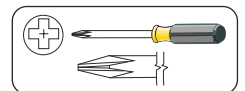
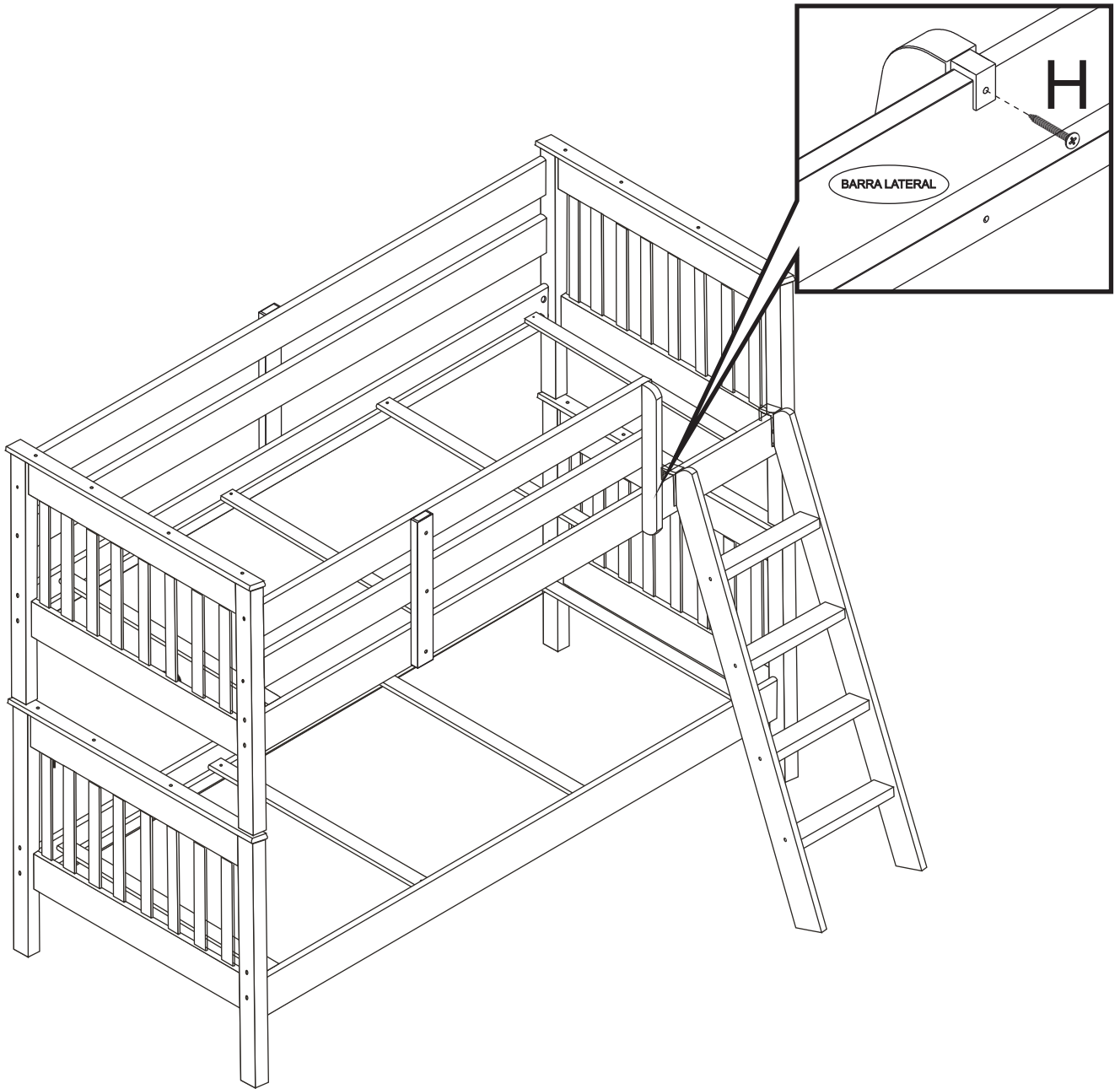
11



H   Qtd
3,5 x 16 Parafuso **02**